



Research topics

Haruichi Kanaya

Kyushu University

Web: <http://yossvr0.ed.kyushu-u.ac.jp>

E-mail: kanaya@ed.kyushu-u.ac.jp

RFIC Japan



Frequency allocation

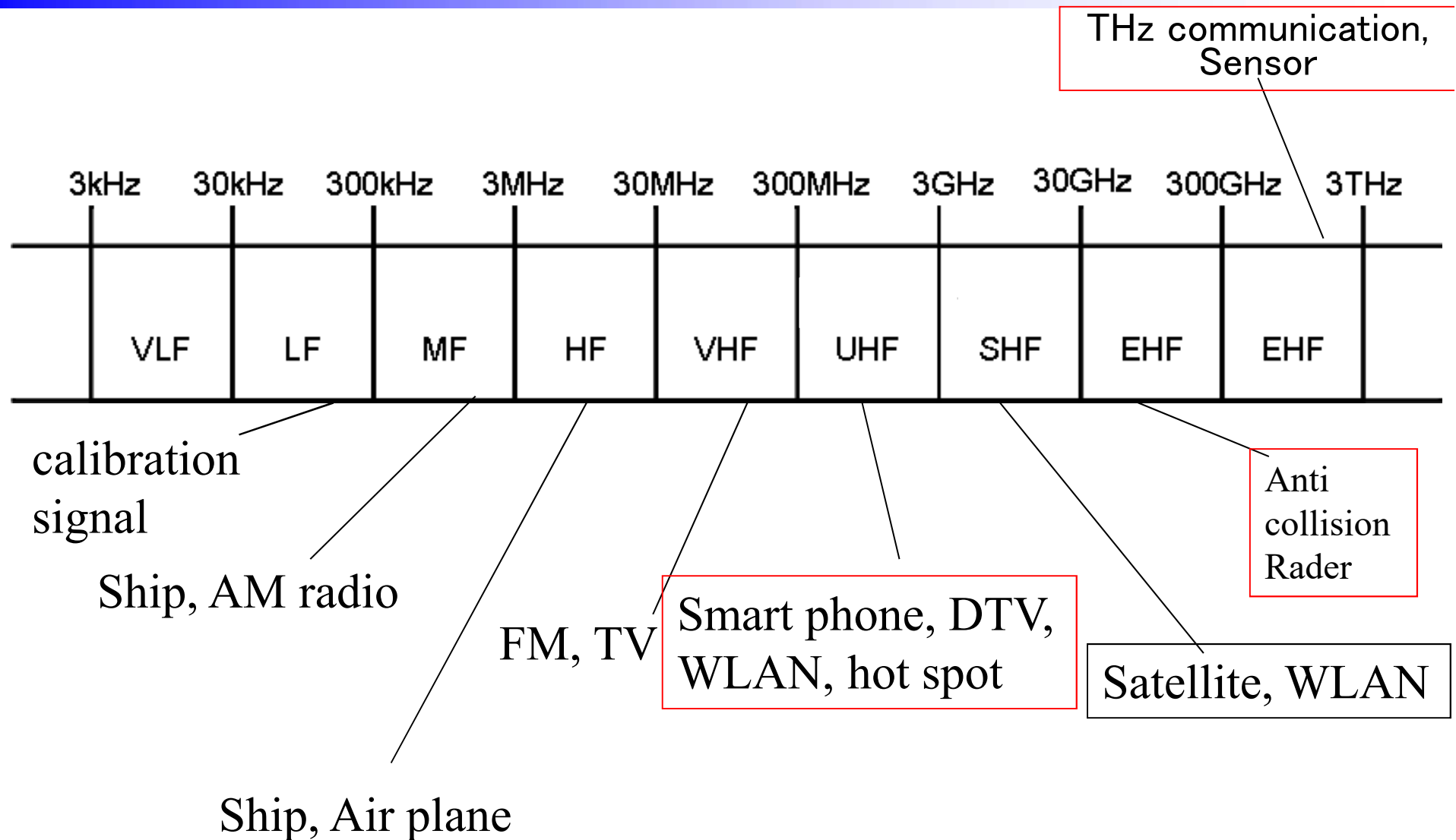

UWB Amplifiers

TSMC 0.18um CMOS

UWB Power Amplifier

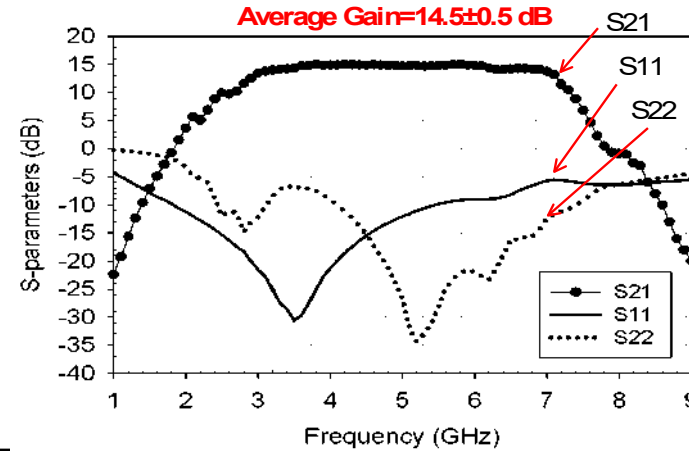
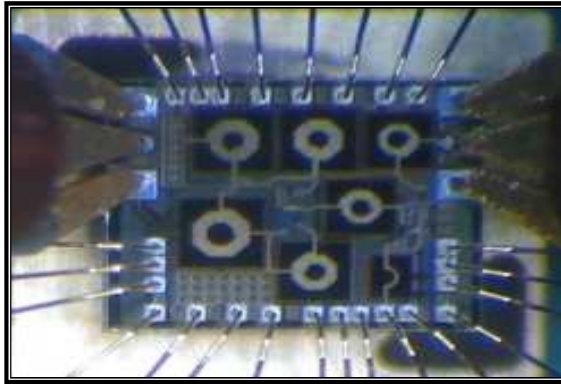

UWB Low Noise Amplifier

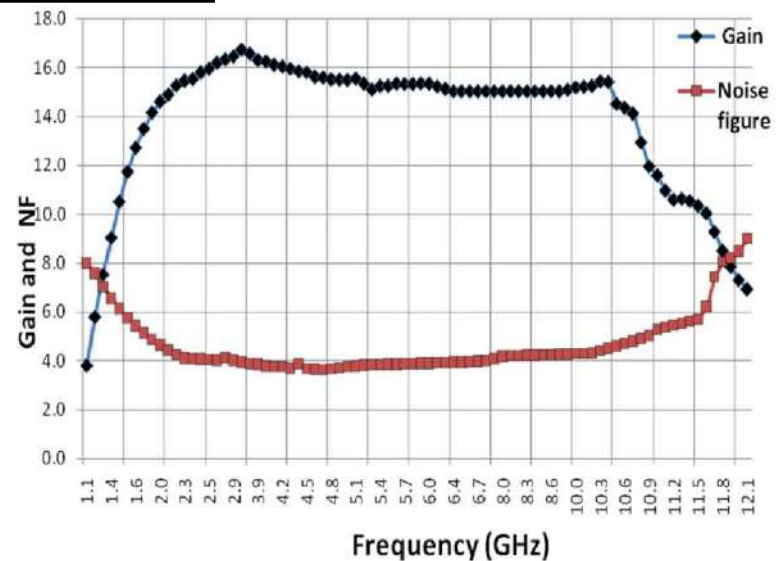
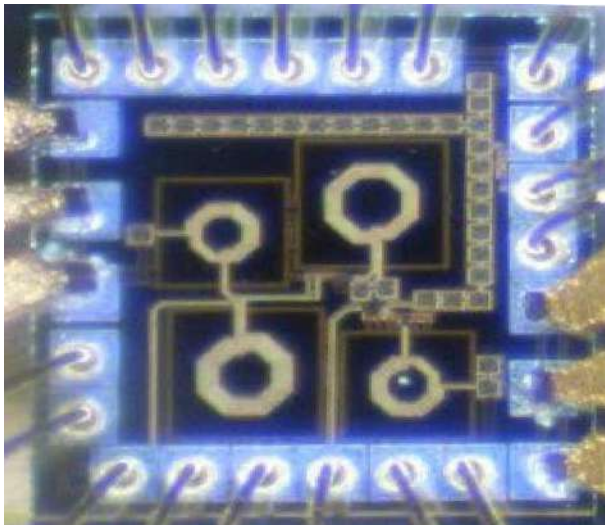

LNA-Mixer (Down converter)

Measured Voltage Gain vs. IF frequency

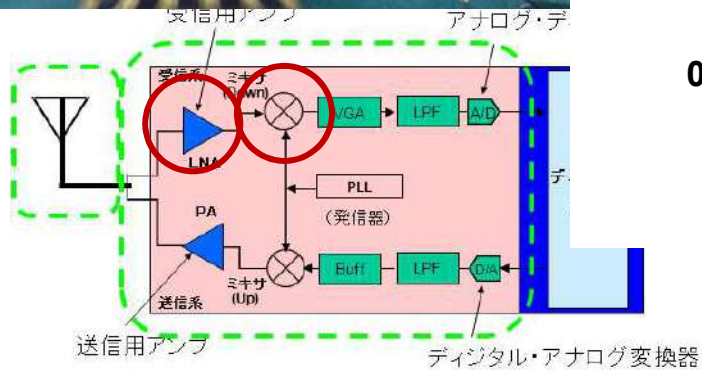
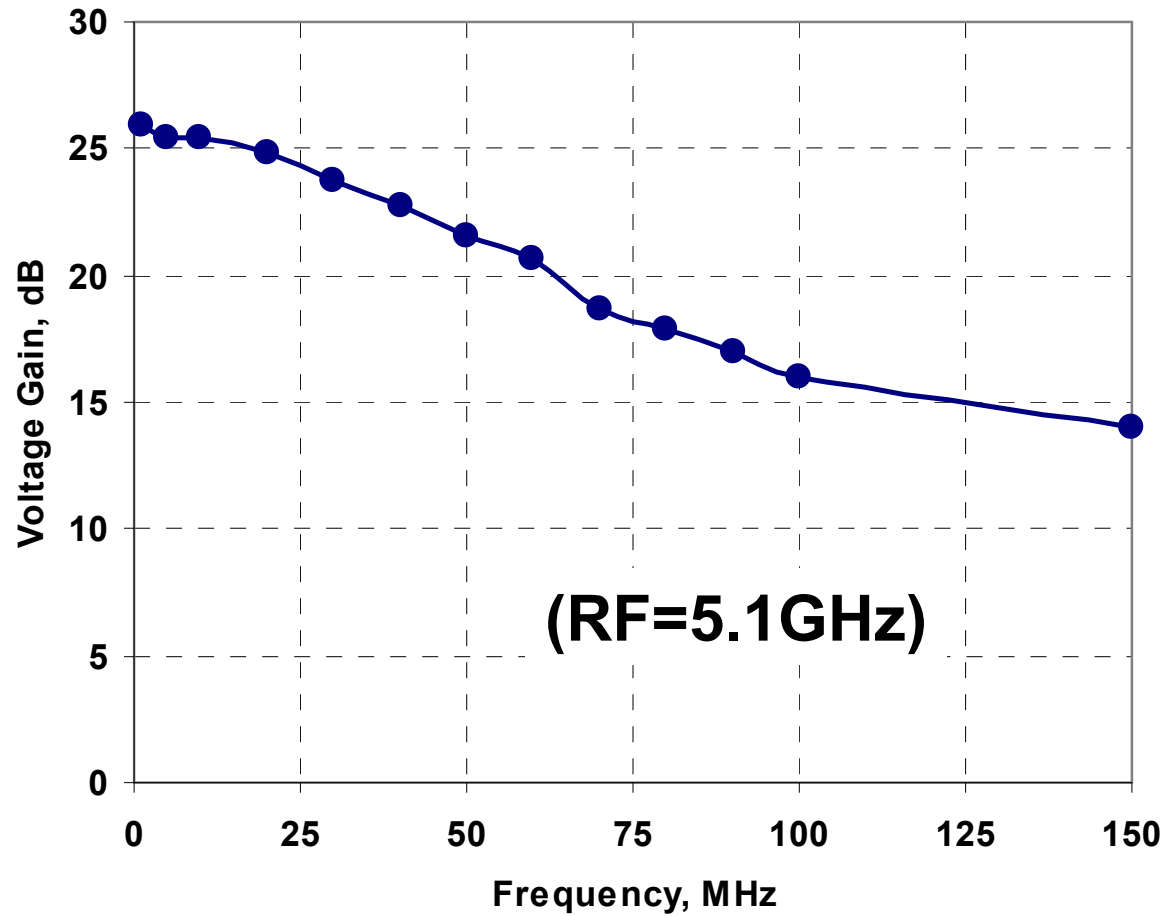
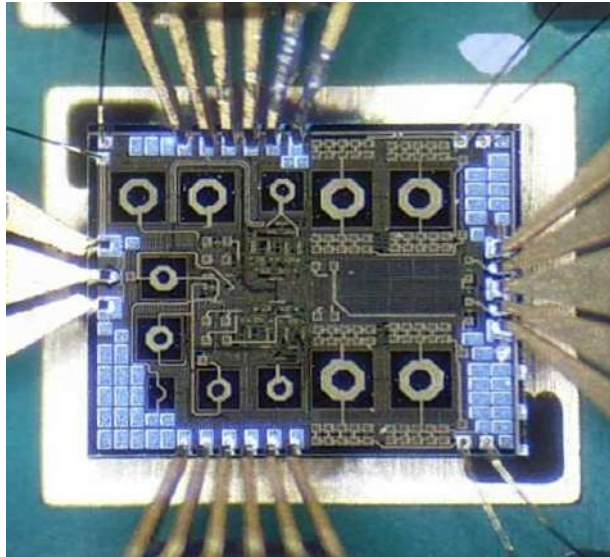

5GHz power amplifier module

Chip photo

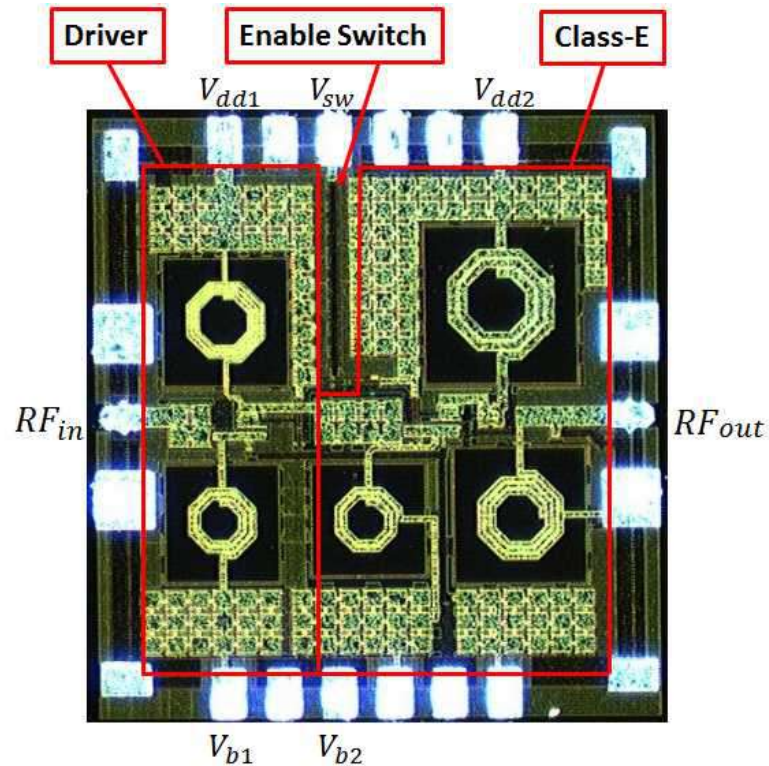

Chip size: $0.9 \times 0.9\text{mm}$

Packaging

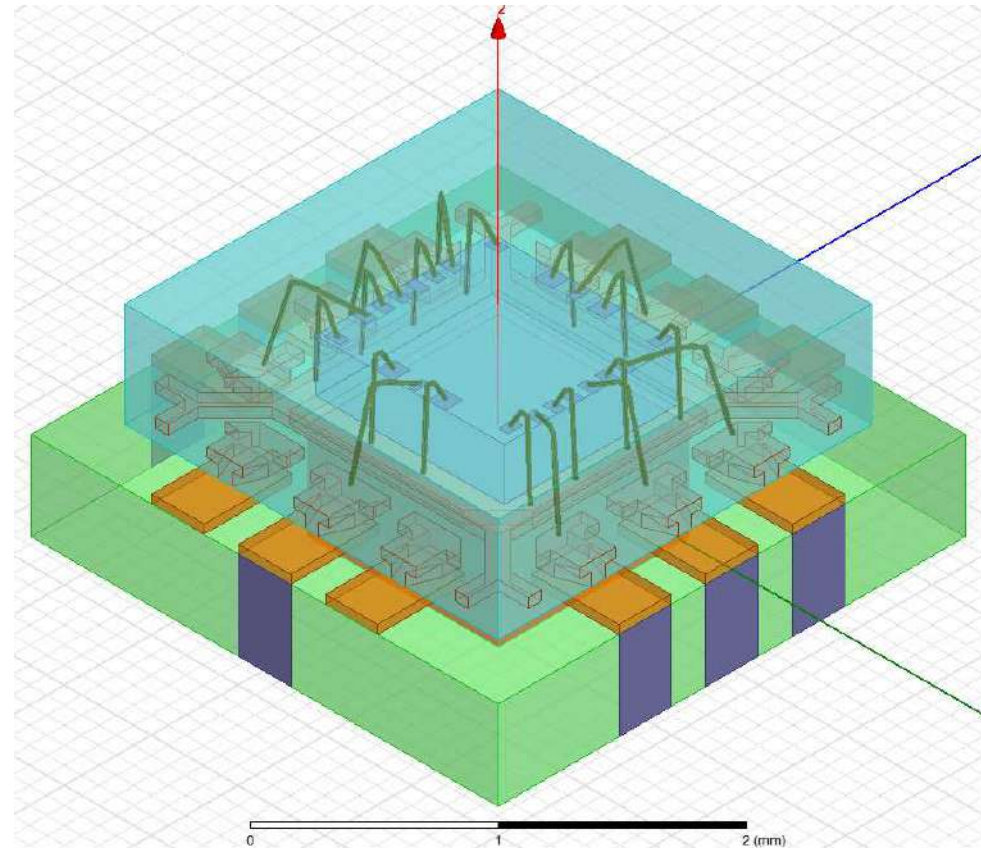

CAD tools: ADS , Vioruso
Technorogy: TSMC $0.18\mu\text{m}$ CMOS

Measured results

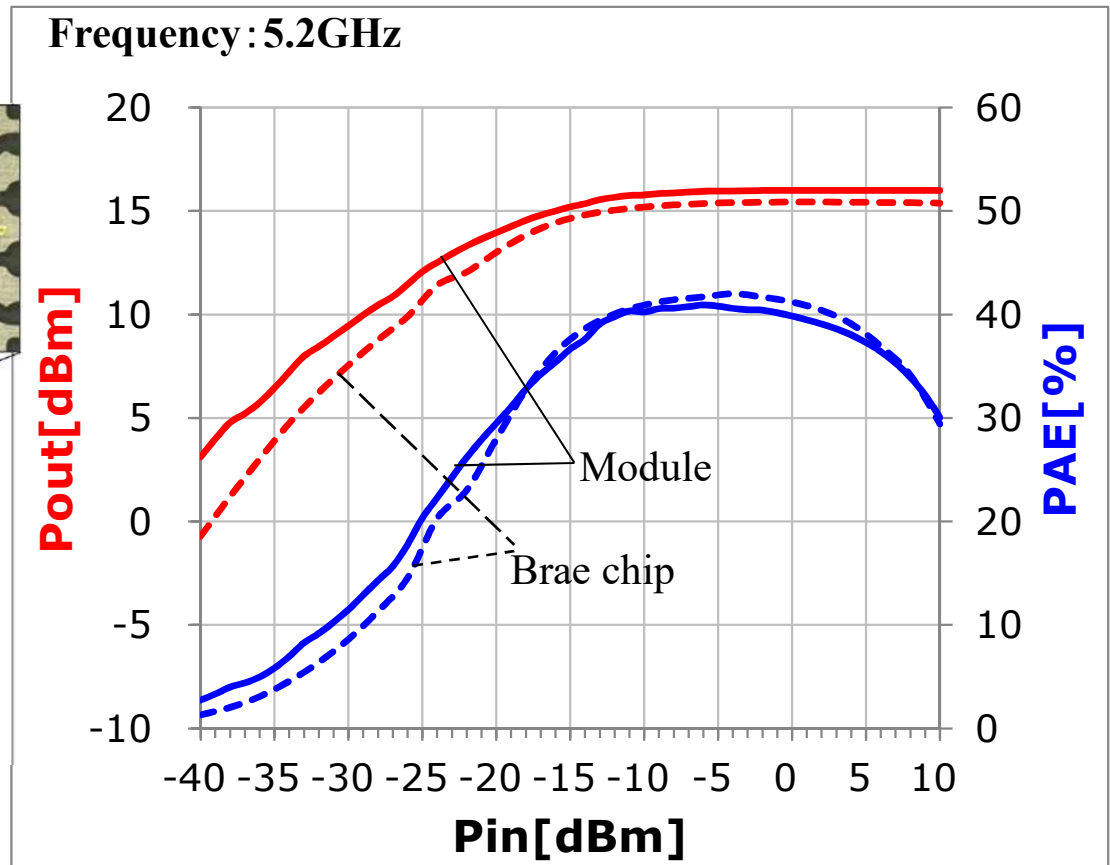
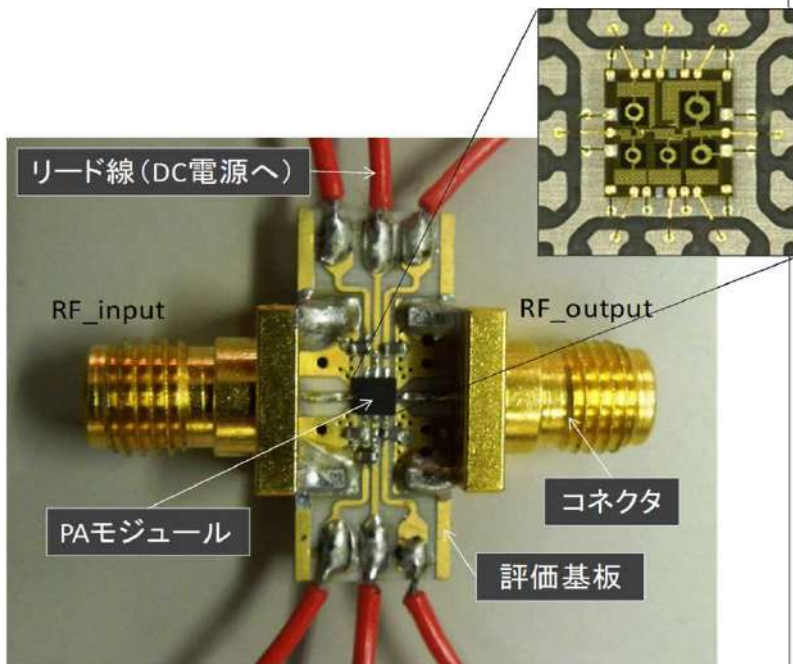

Input-output comparison

	Bare chip	Module
Pout[dBm]	15.4	15.9
PAE[%]	42.0	41.0

No performance degradation

Antenna design



UWB Full band antenna on flexible substrate

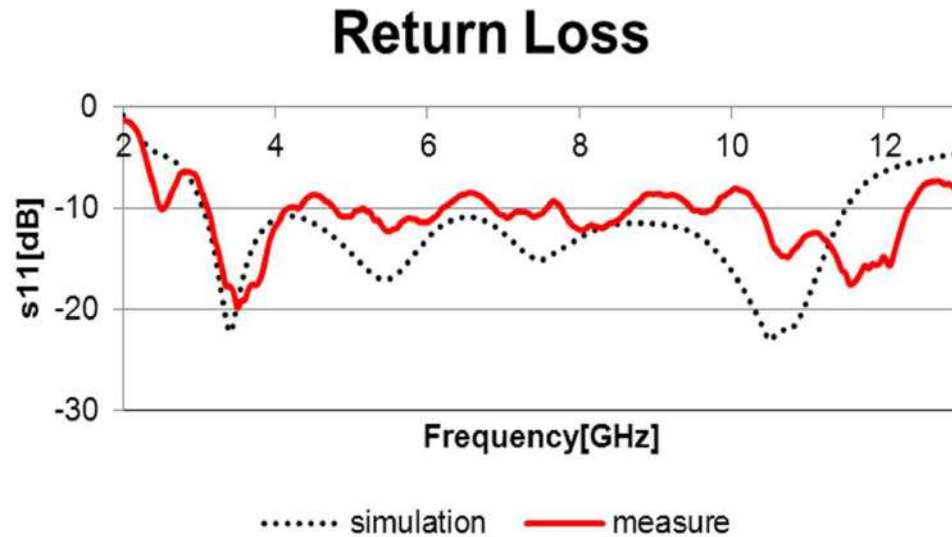

Bandwidth: 3.1~11.4GHz

Radiation patterns (yz plane)

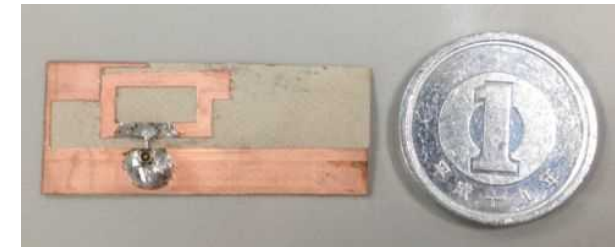
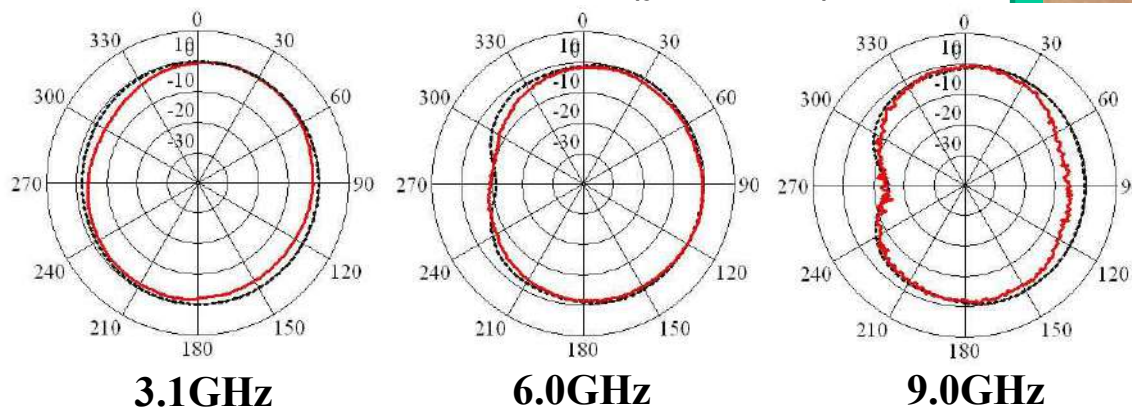

Plaster: 70 mm x 18 mm

Future Image

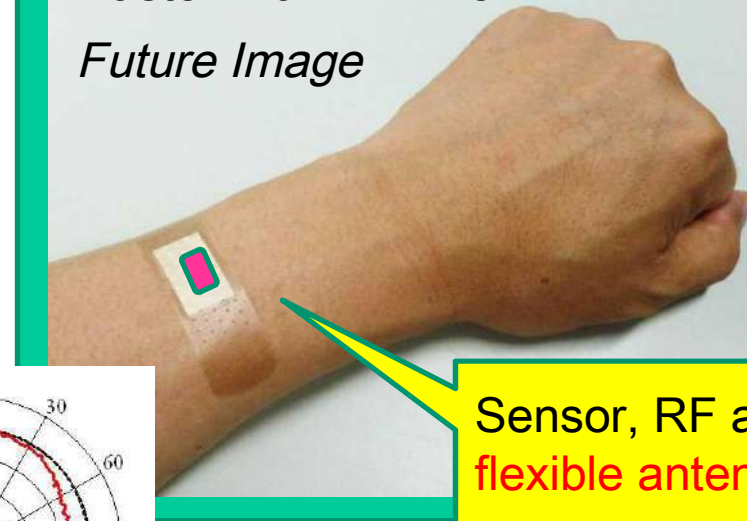

Sensor, RF and flexible antenna

--- simulation — measure

Comparison table

Patch antenna

One-sided directional slot antenna

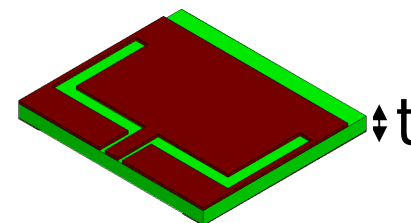
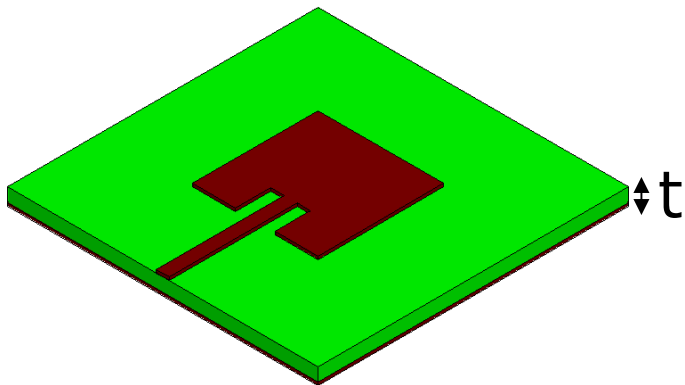

Size reduction (No large GND)
Thin substrate

	Thickness t [μm]	100	150	200	300
One-sided directional slot	Gain [dBi]	3.35	3.73	5.29	5.62
Patch		-1.41	2.47	4.73	5.85

@28GHz

5G/beyond 5G 4x4 array antenna

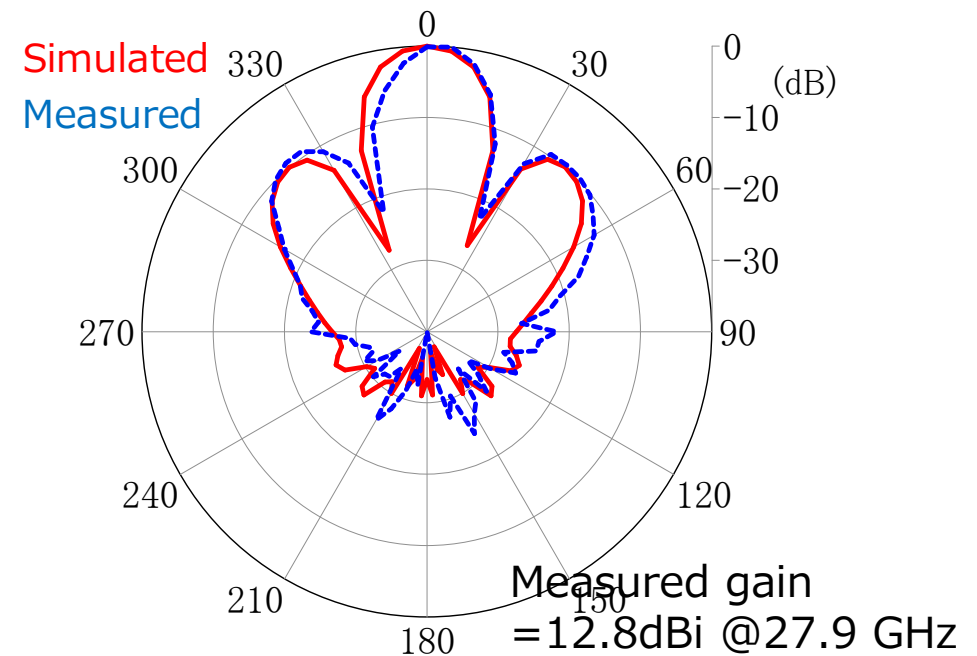
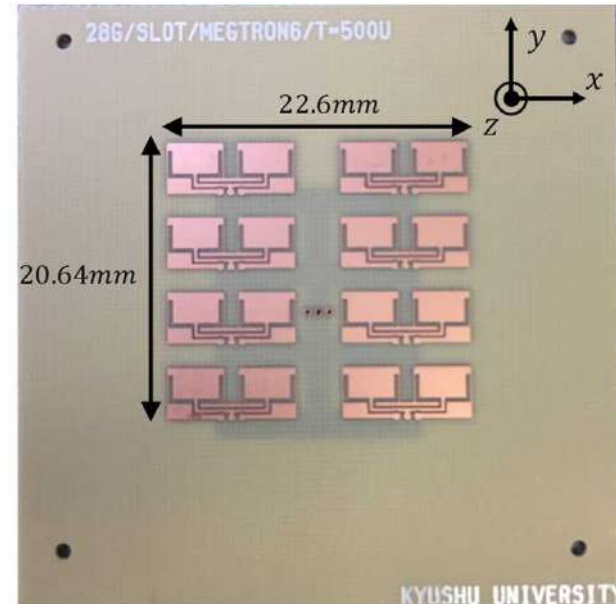
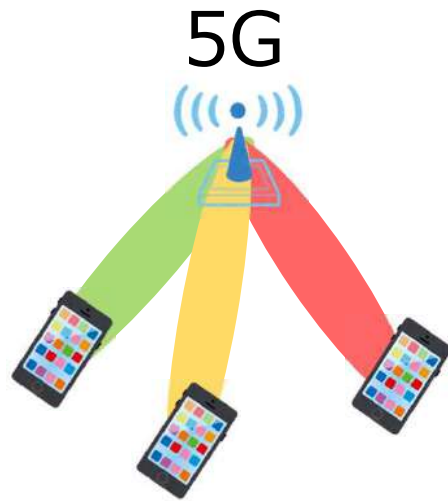

NTT docomo M2M system and Watching security system

@ Kyushu Ten Co.

M2M

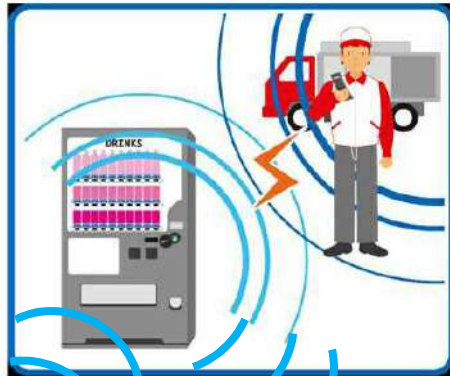

Watching security system



M2M: Machine to machine

THz image sensor

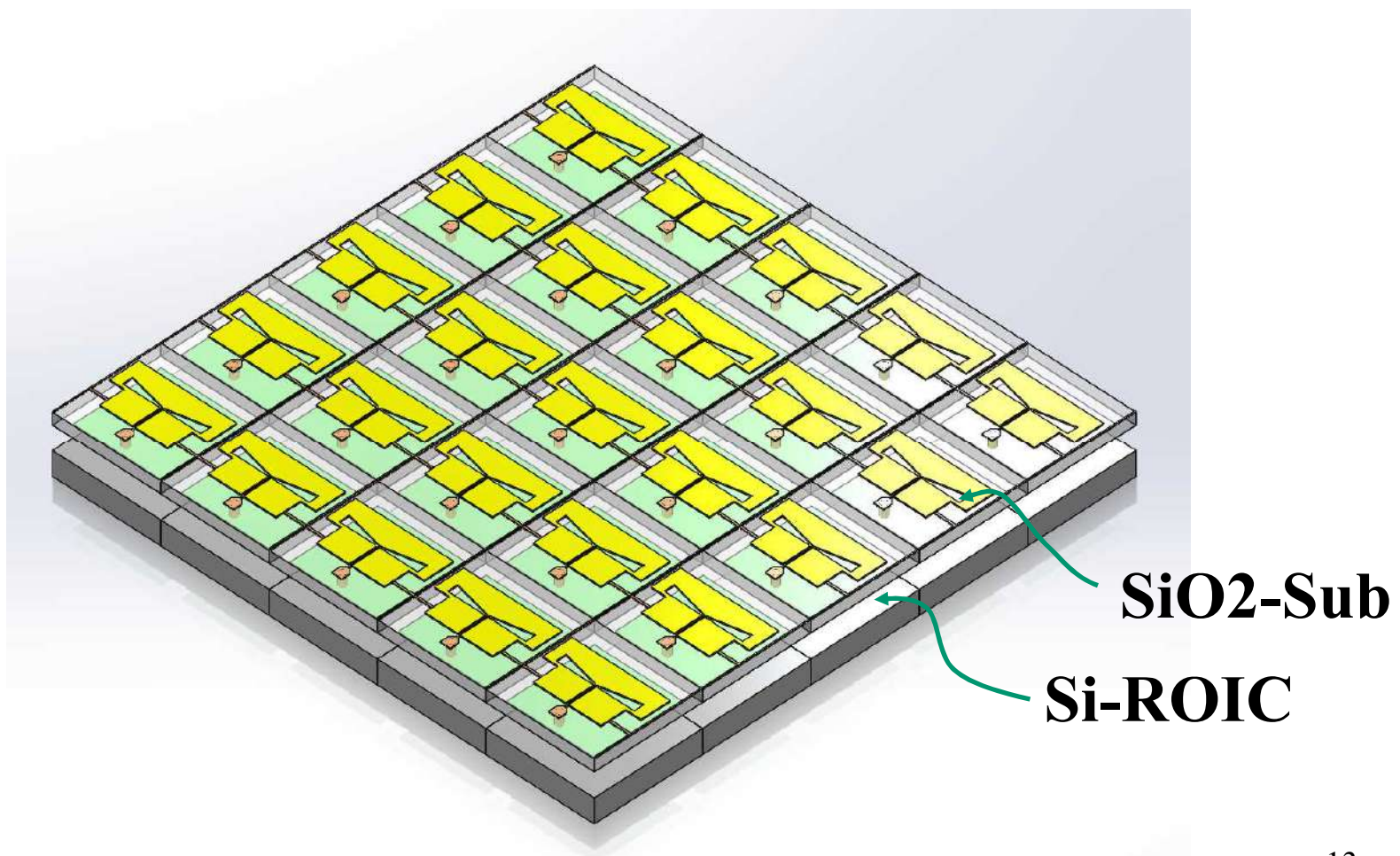

Antenna on quartz for 1THz imaging

290 μm \square

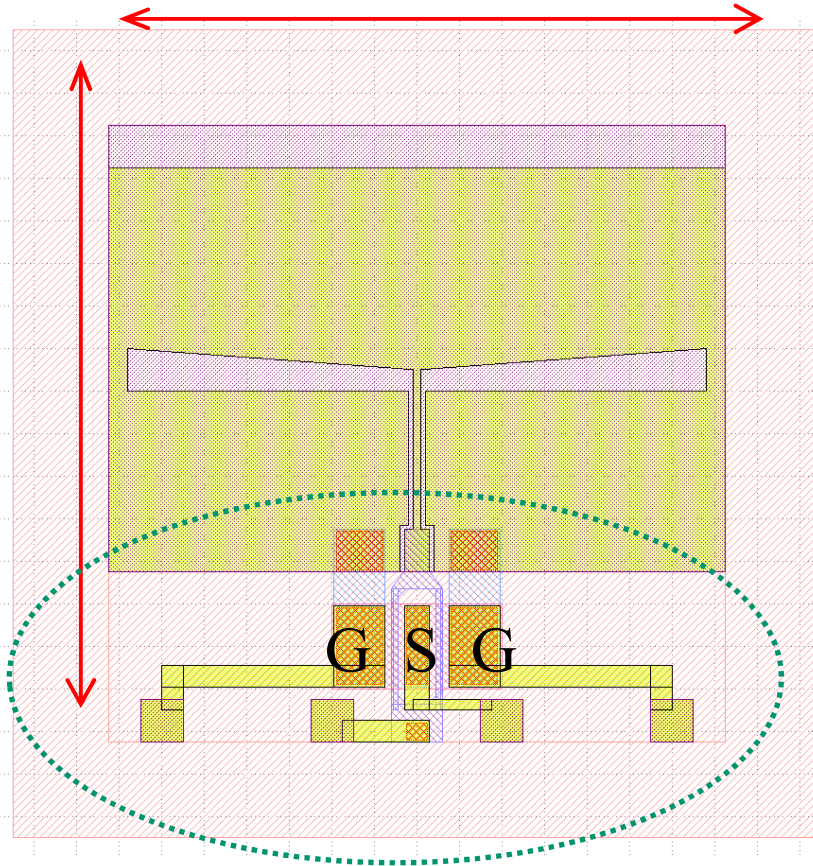

InAs MOS HEMT on quartz glass

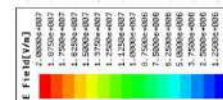
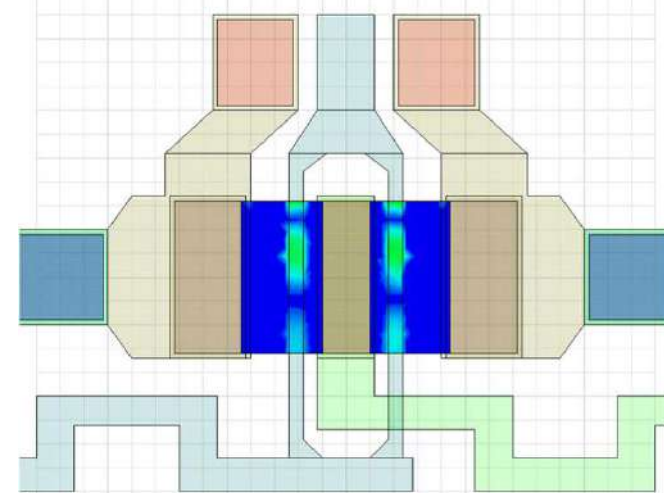
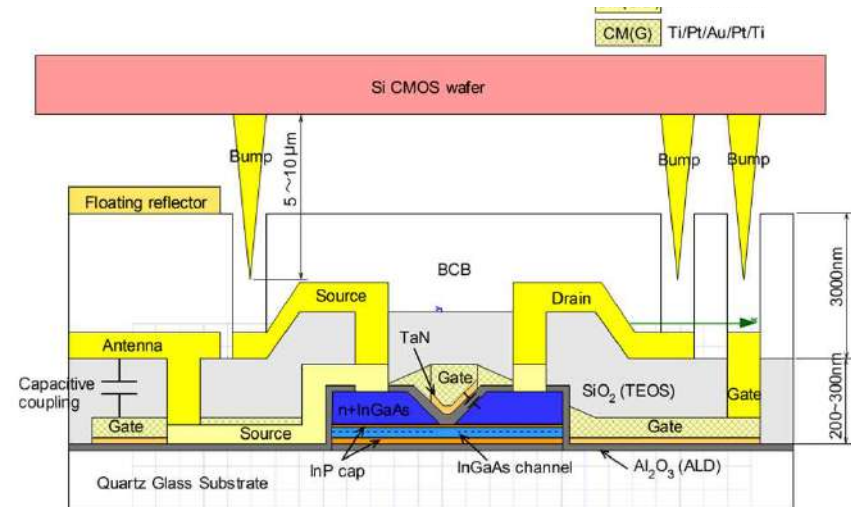

1THz Measured setup

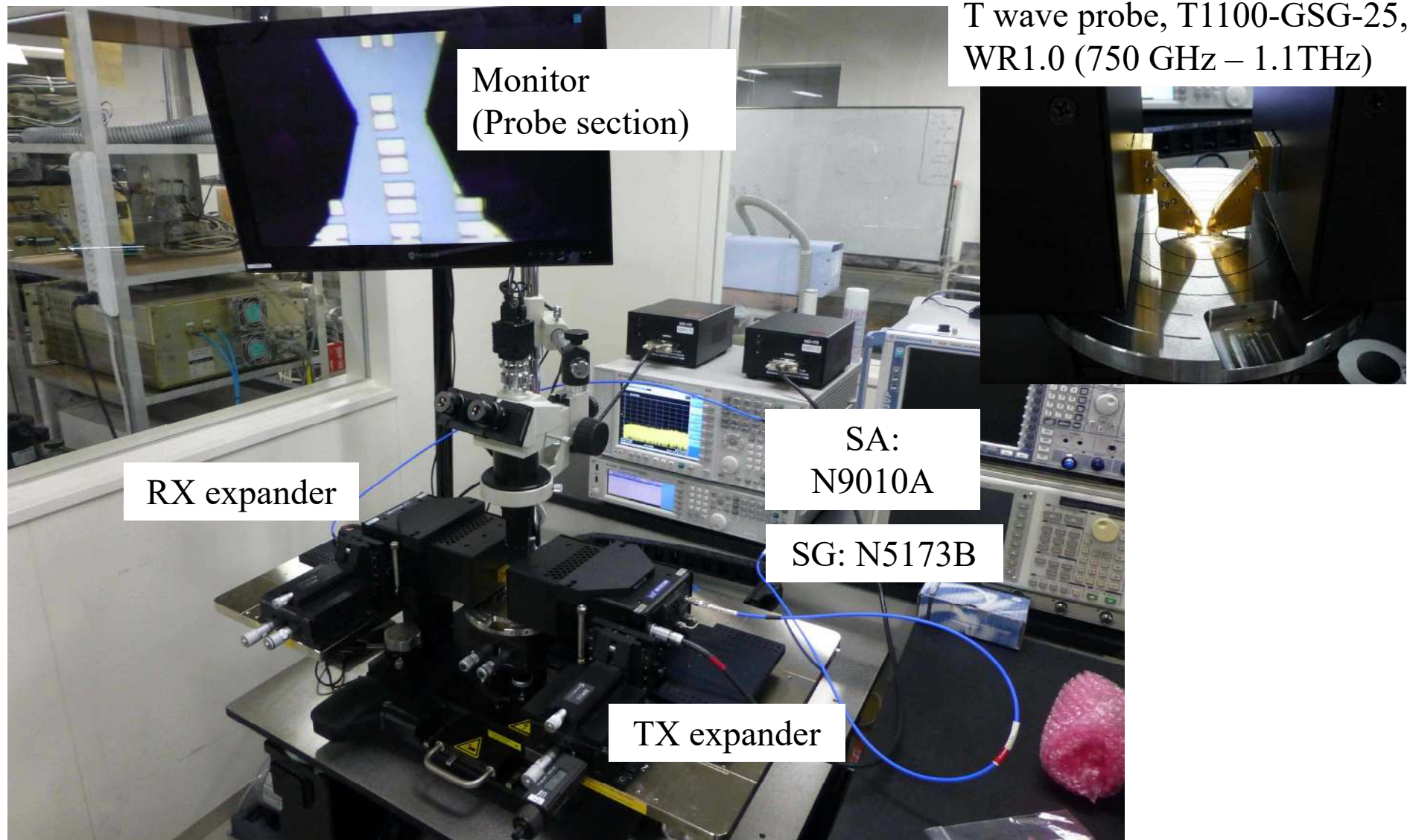

Antenna measurement

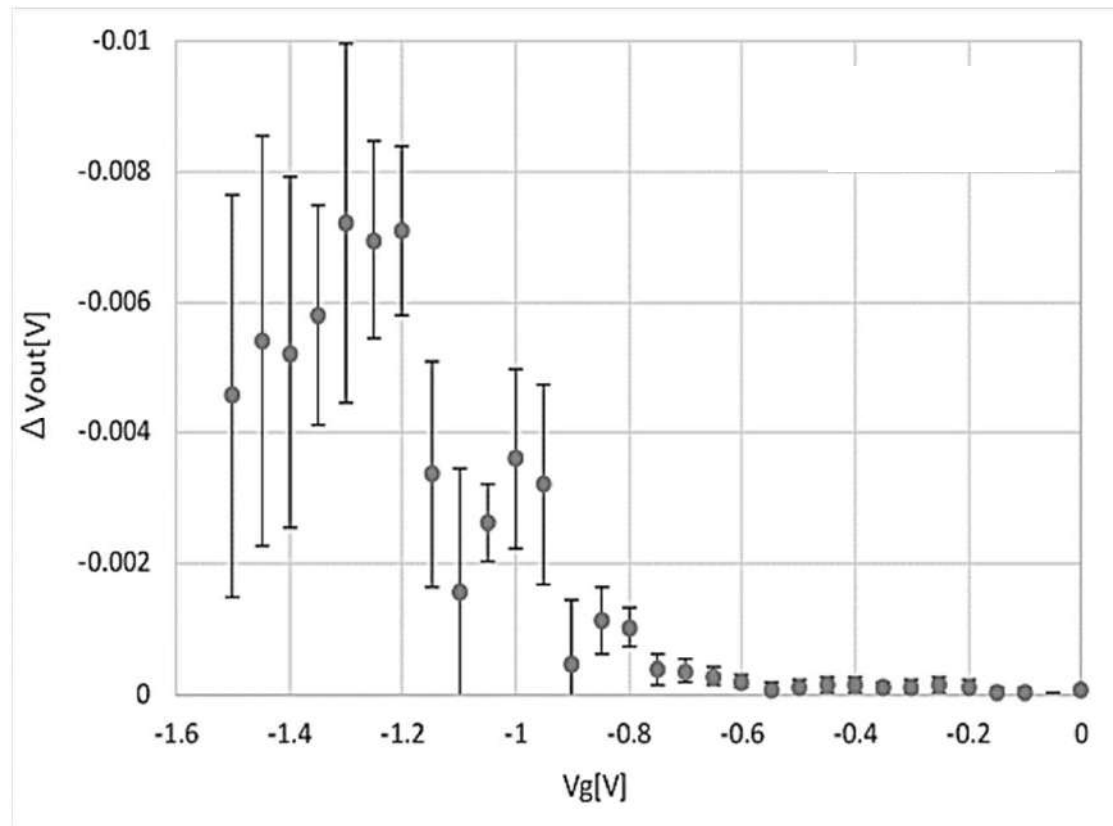
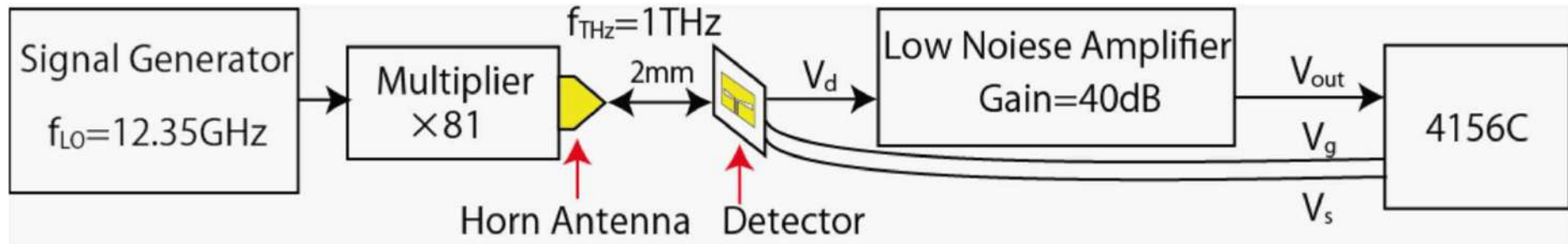

Energy harvesting

Numerous unused energy sources exist for producing sufficient electrical power to run low-power embedded systems.

Different technologies of energy harvester

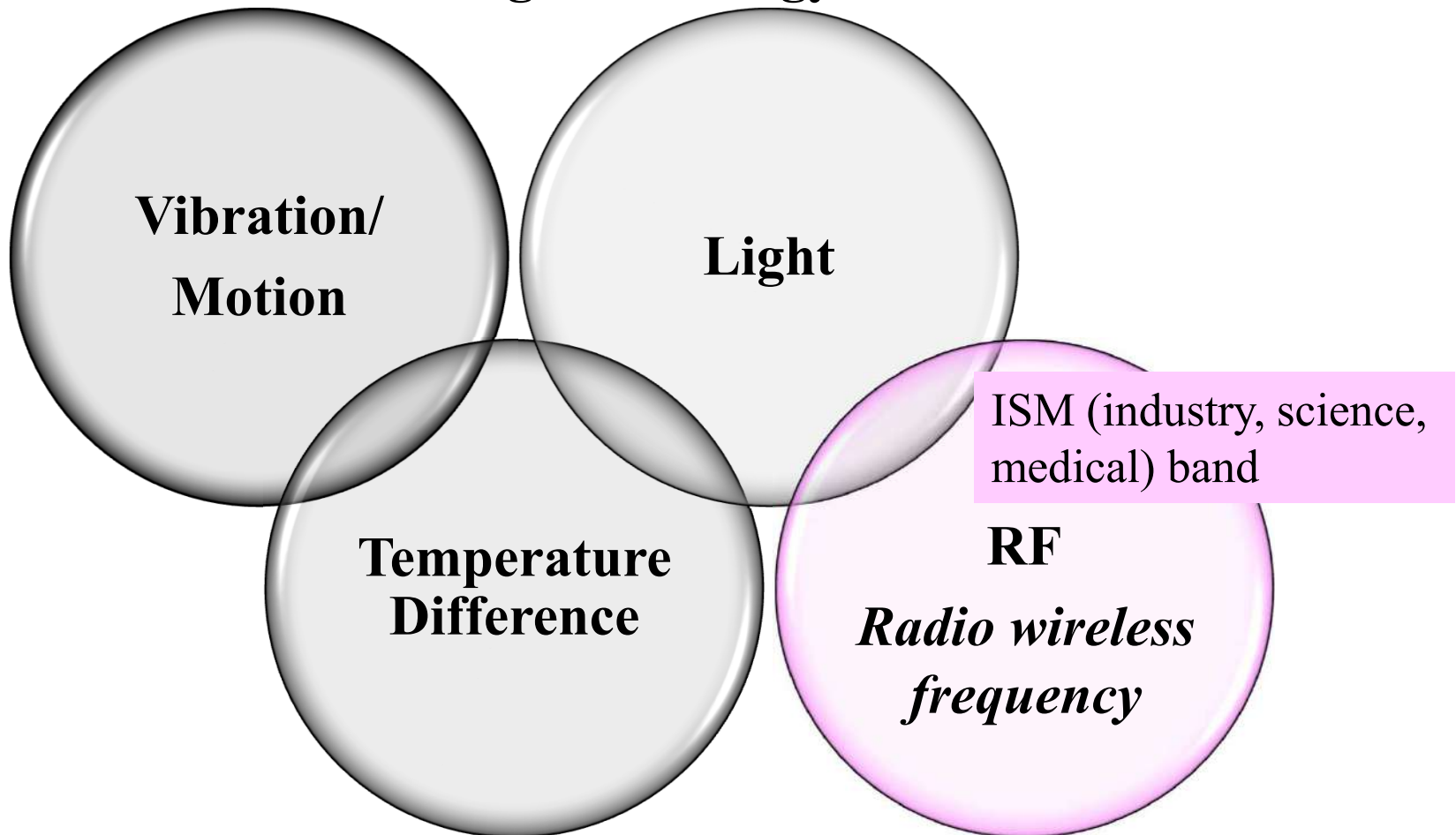



Medical application

Endoscopic surgery

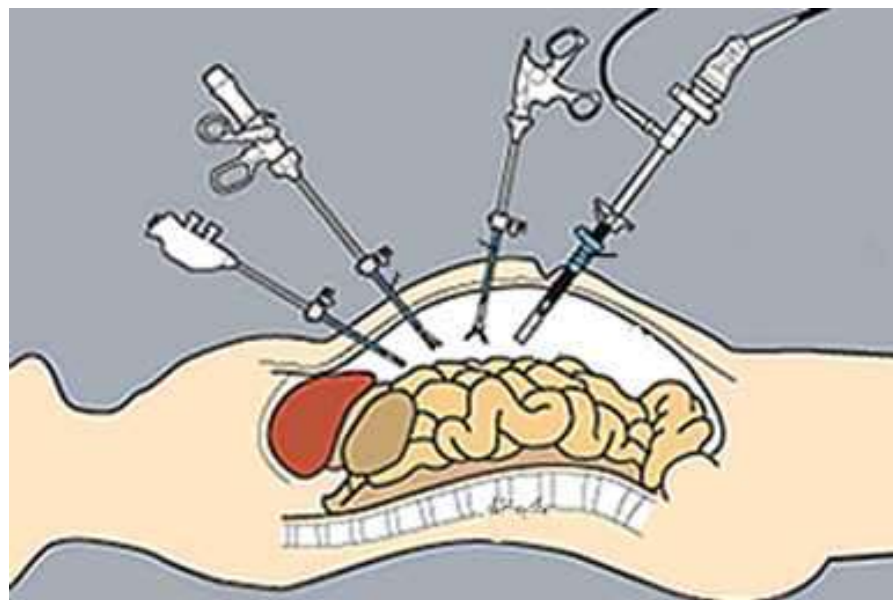

Radiography system
exposure



protective clothing



Camera

Out side of the
stomach and
intestines



Radiography

In side of the
stomach and
intestines

Medical application

Before operation

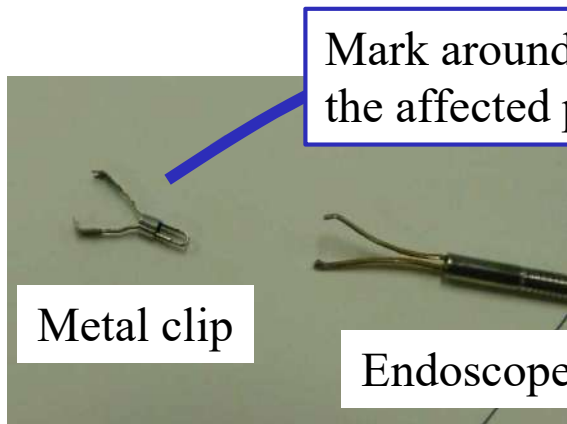

Clip for endoscope

Remove affected part

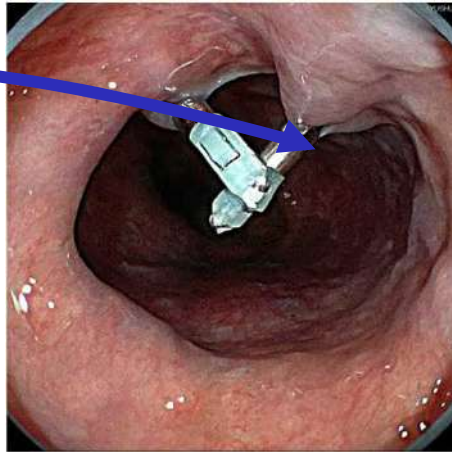

Clip attached

In side of the stomach

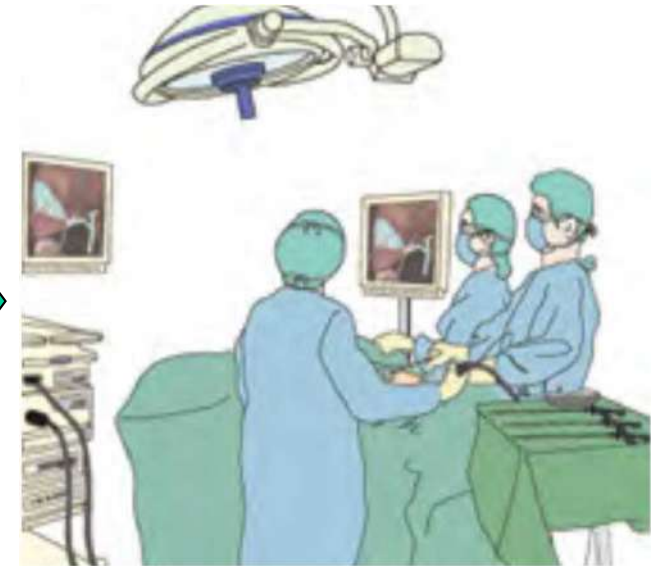

Endoscopic surgery

Radiography system should be needed.

A laparoscopic image and a radiograph are different.



Radio wave from an electric scalpel

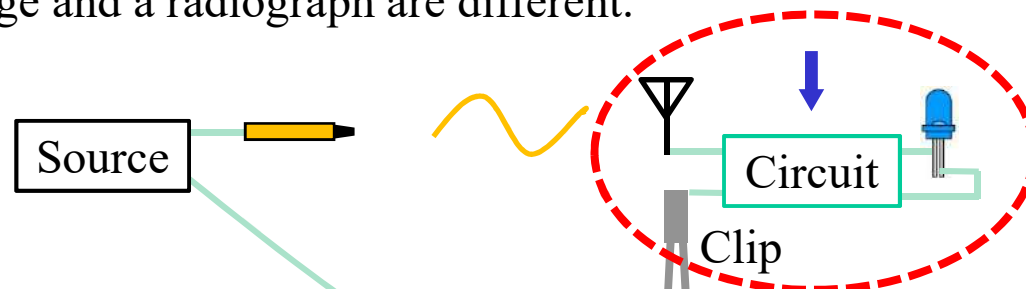

- Visible
- Eliminate the radiograph equipment

Miniaturization for imprint application

- Electro magnetic wave circuit
- Size reduction
- Medical equipment

LED marker without any batteries
for Endoscopic surgery
Source: electric scalpel

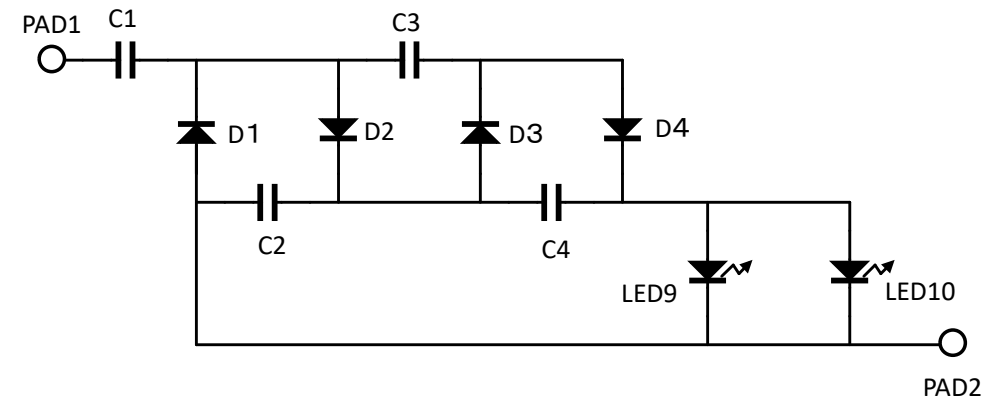
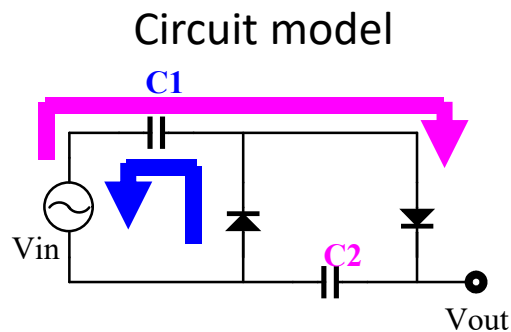

Test chip (2φ x 18 mm = Endoscopy)

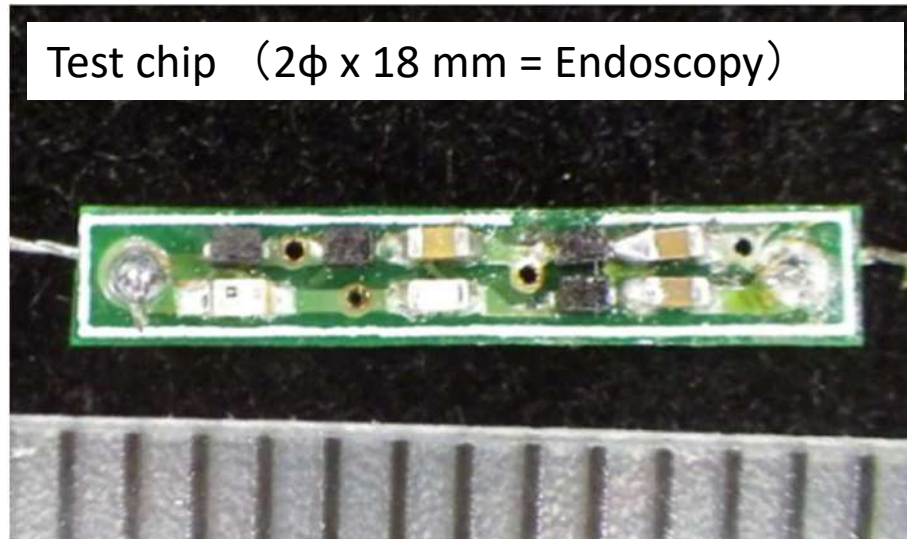

Experiment with pig (weight =30kg)

21



LED was clipped on the Stomach anterior wall.



21



LED lightning (Inside the stomach)

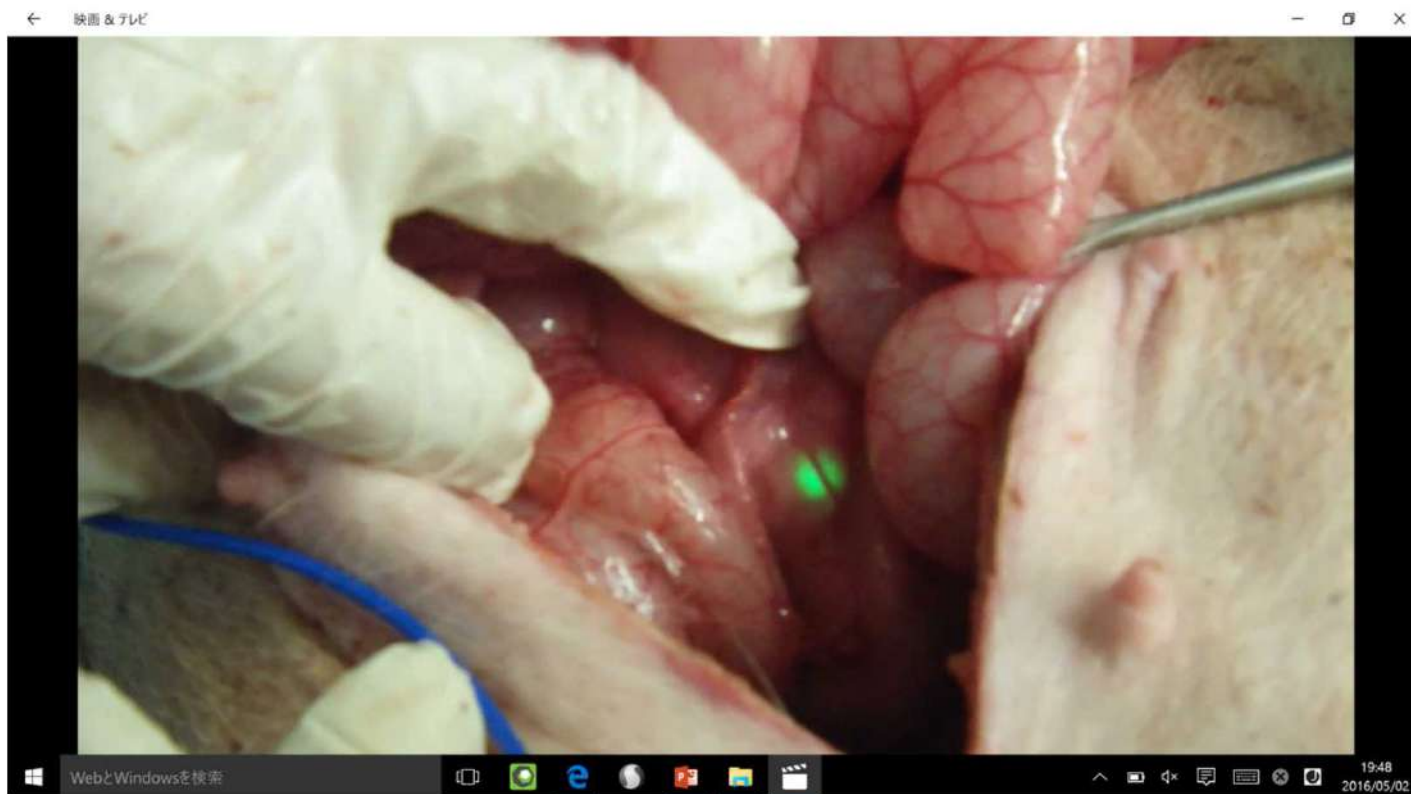

Energy Harvesting Circuit with Planar Antenna

Dr. M. Mansour

8 stage x 3 cets

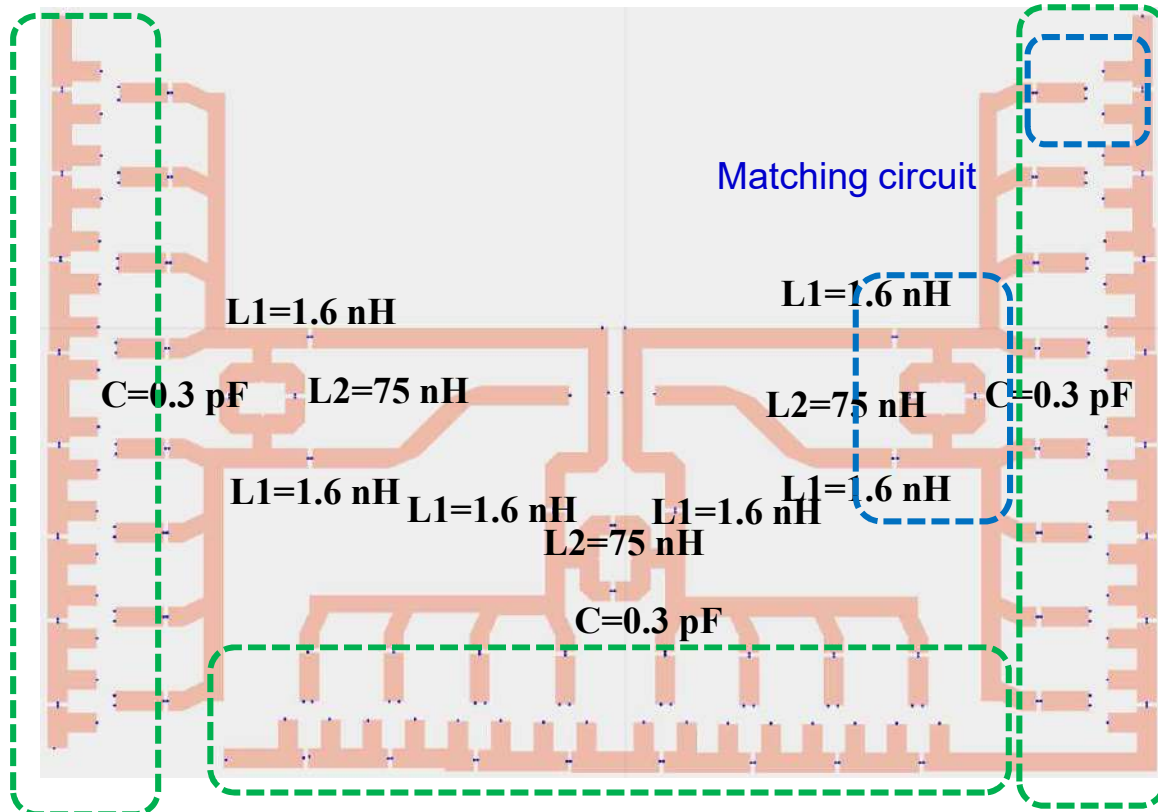

Rectifier unit cell

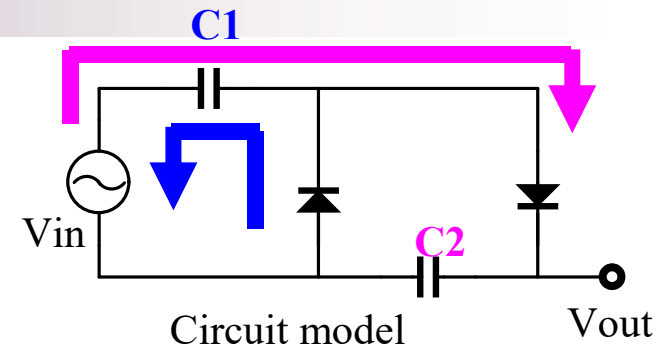

Circuit model

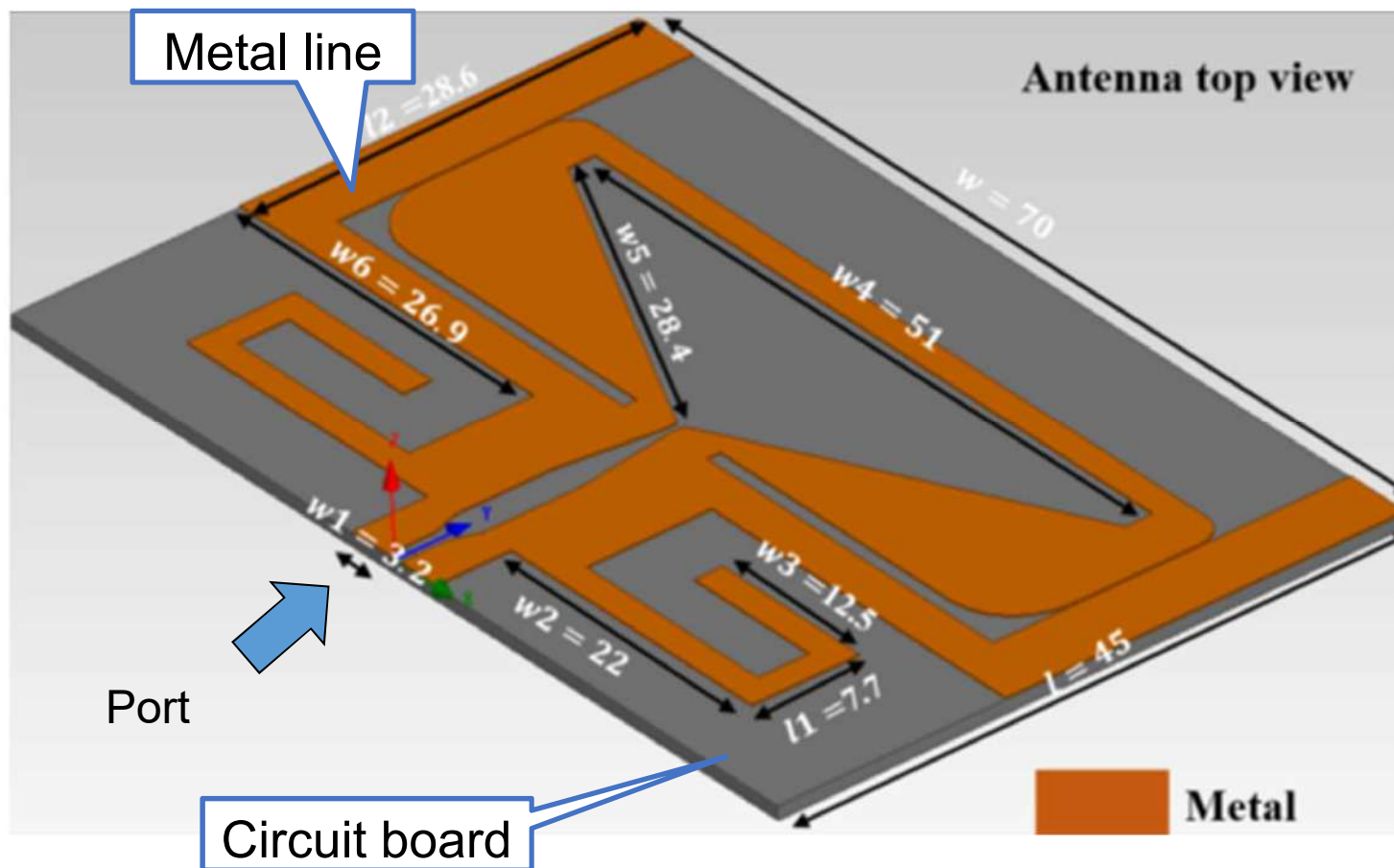

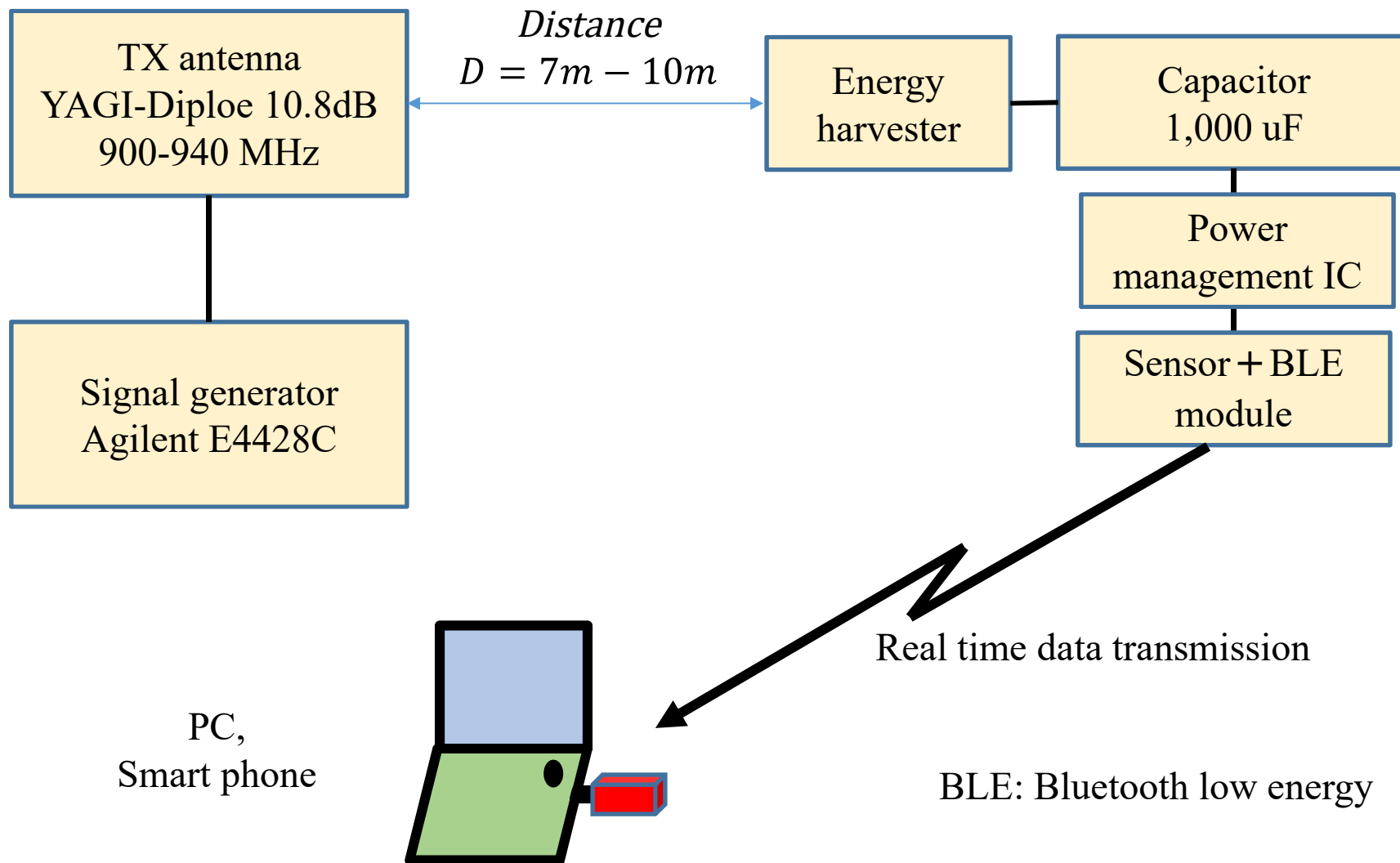



Experimental setup

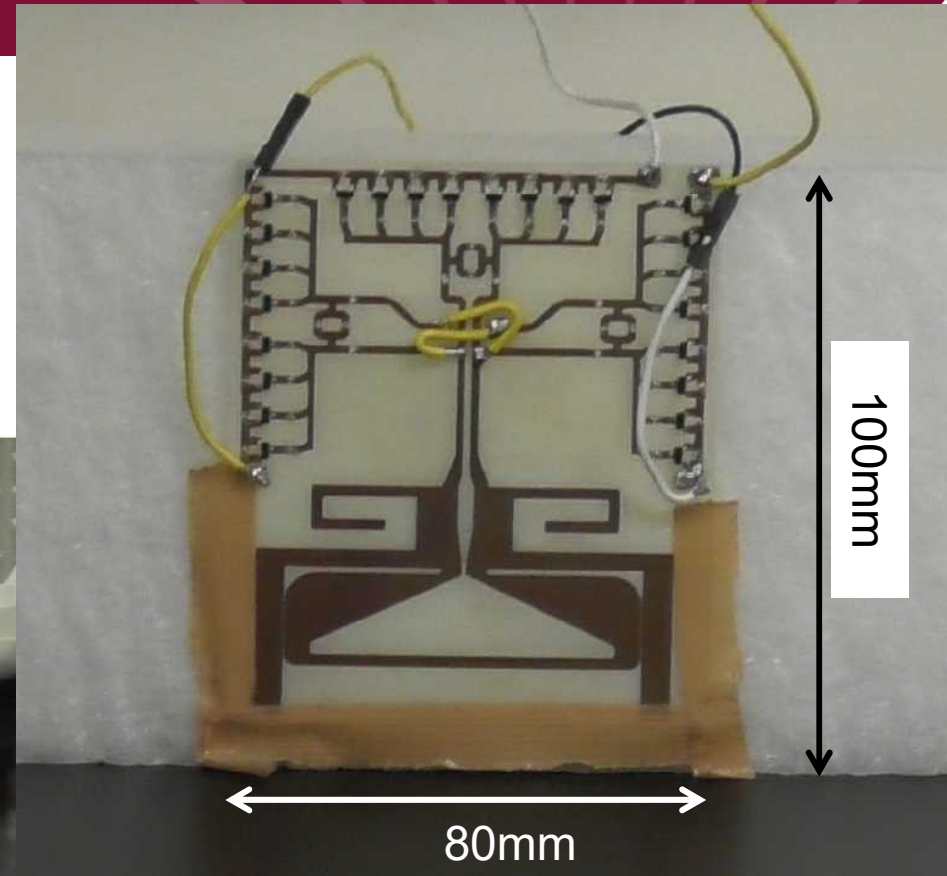
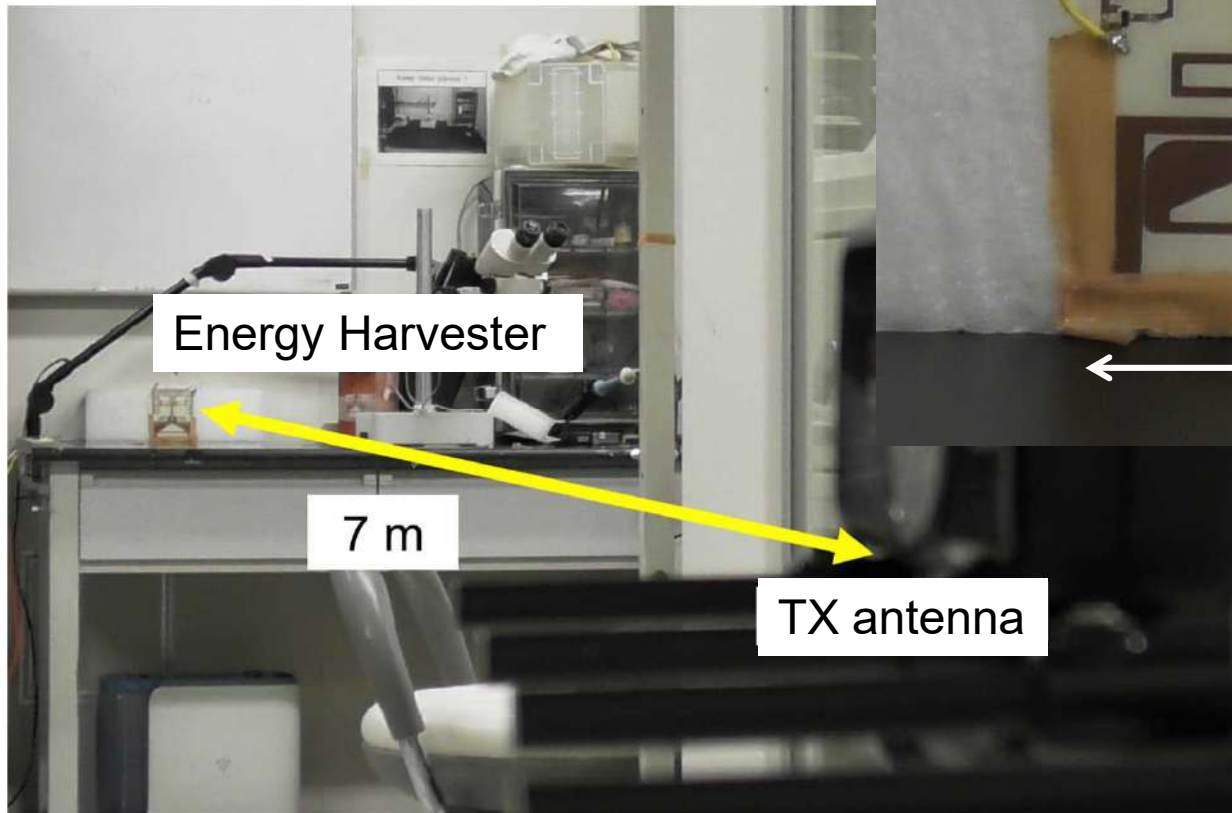

22dBm@920MHz (IMS band)



Voltage drop by the sensing and BLE data transmission

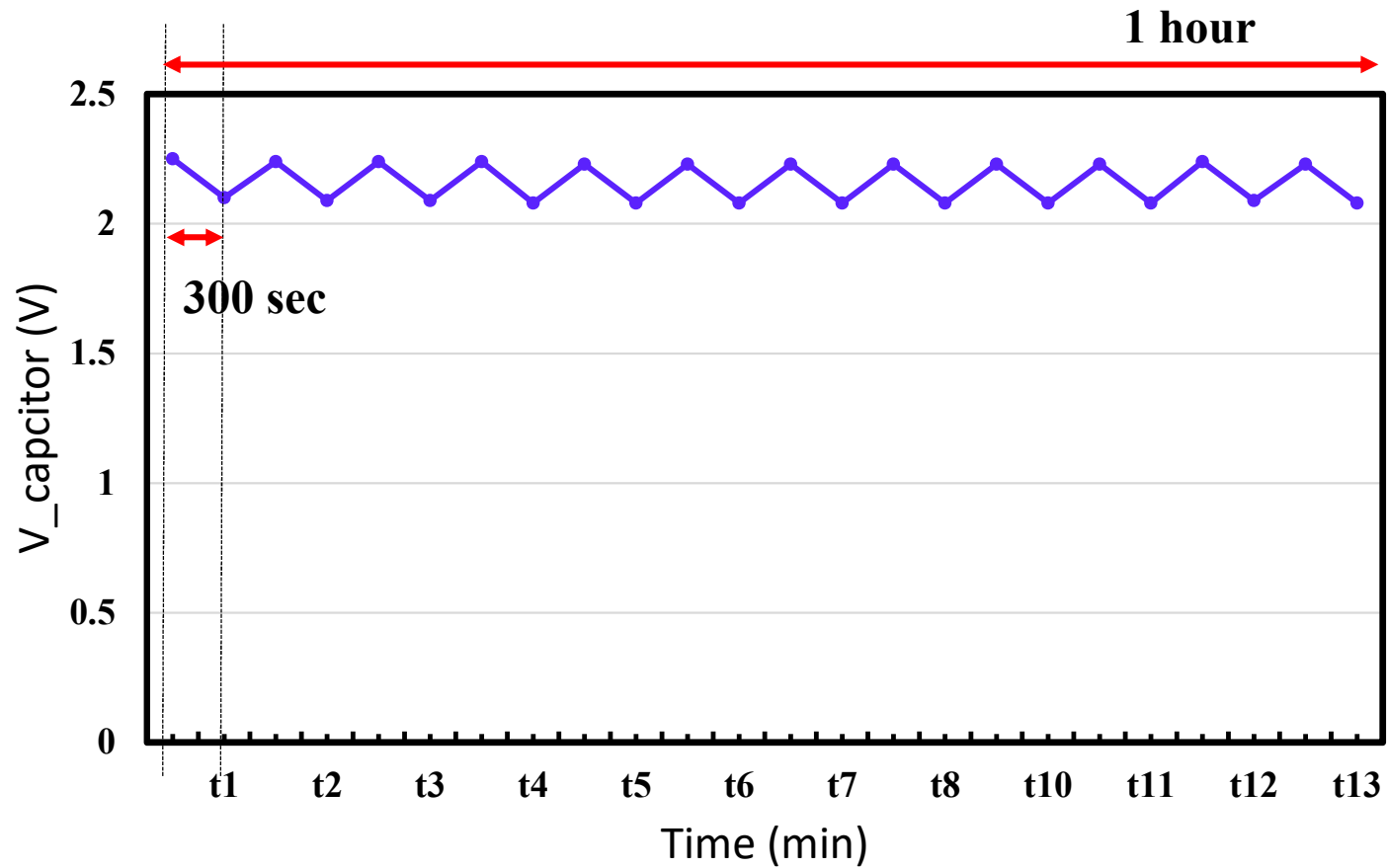



Body surface temperature measurement

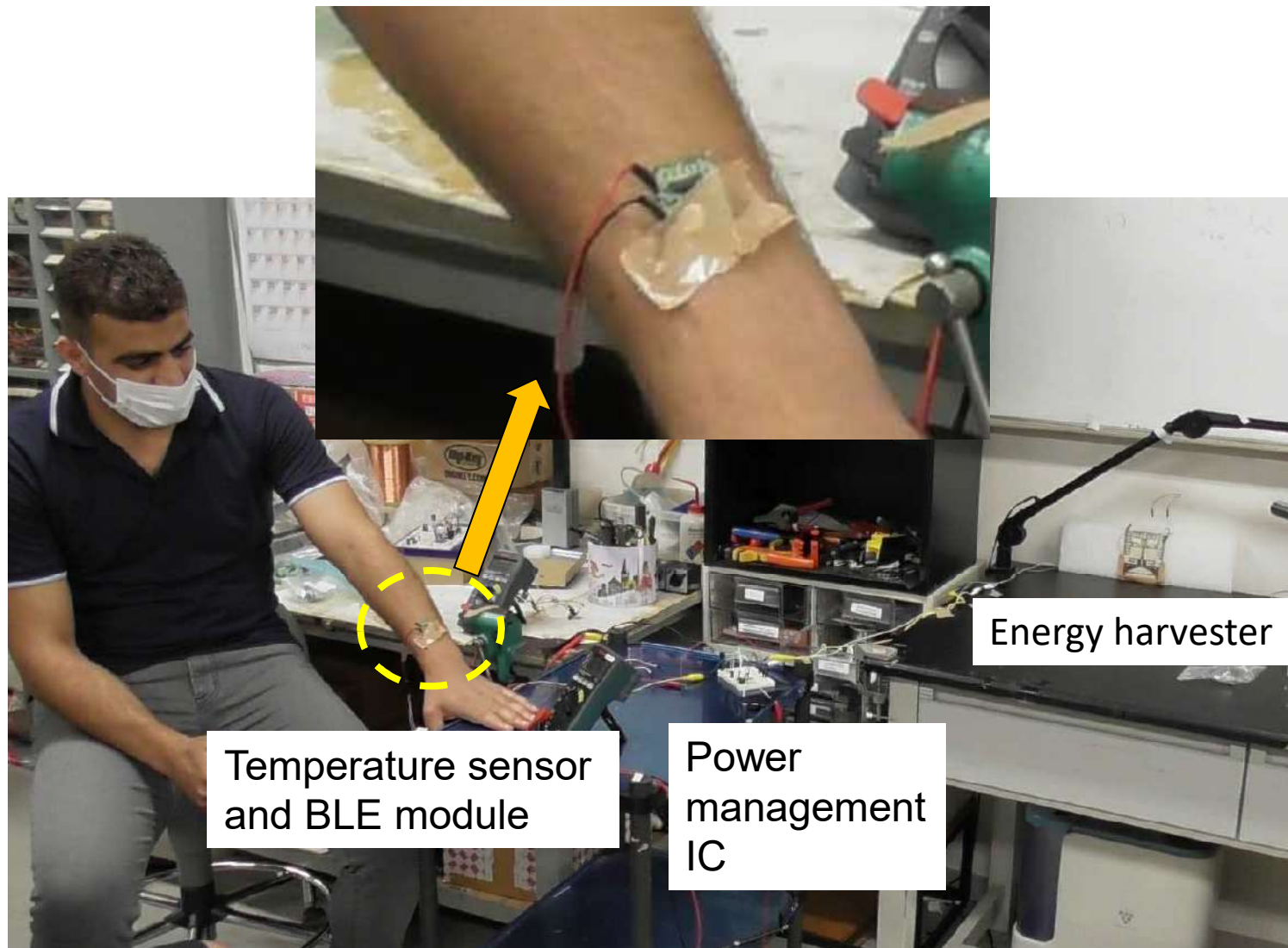

Temperature sensor and BLE module

Power management IC

Energy harvester



Data receiving (BLE)

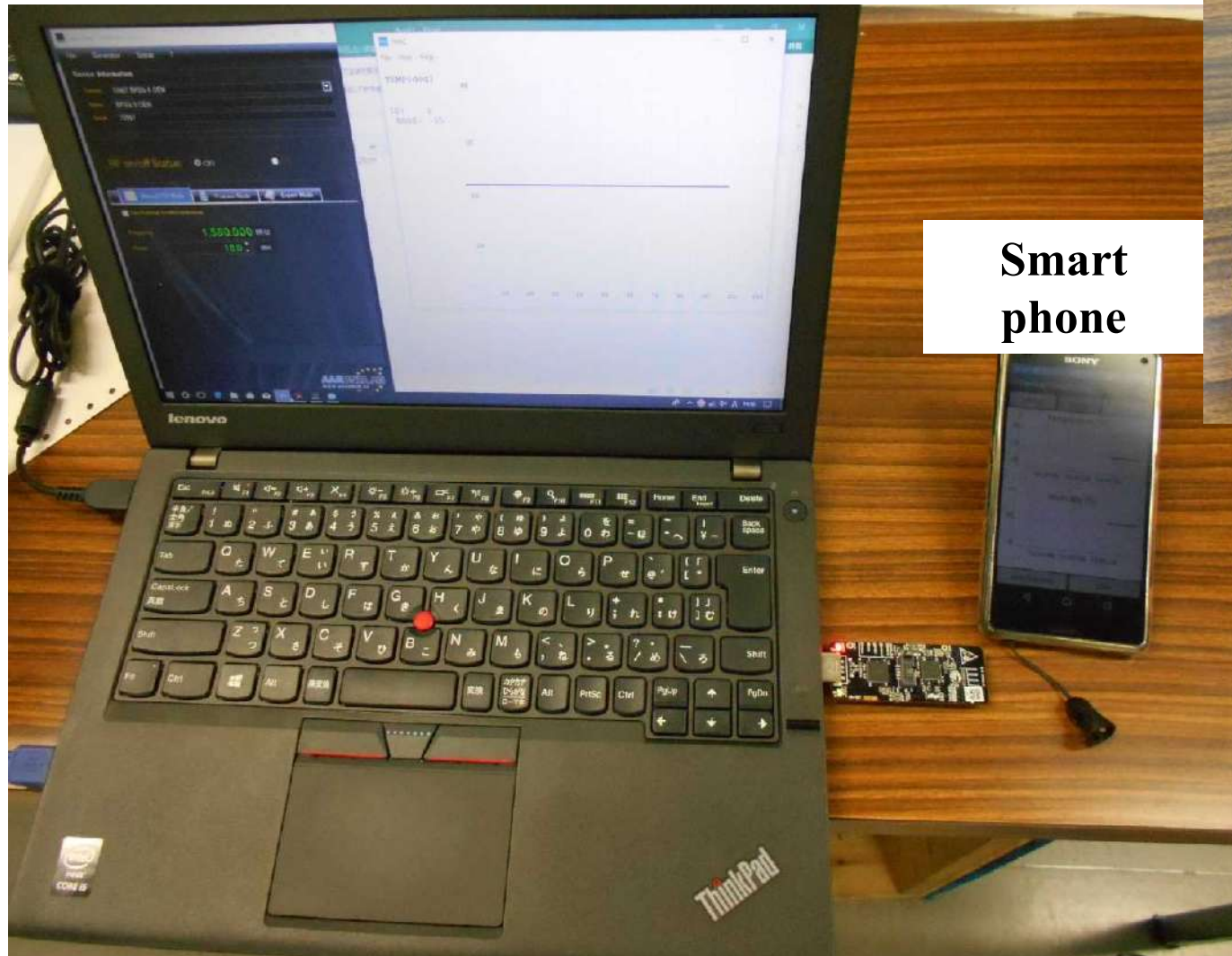

**Smart
phone**

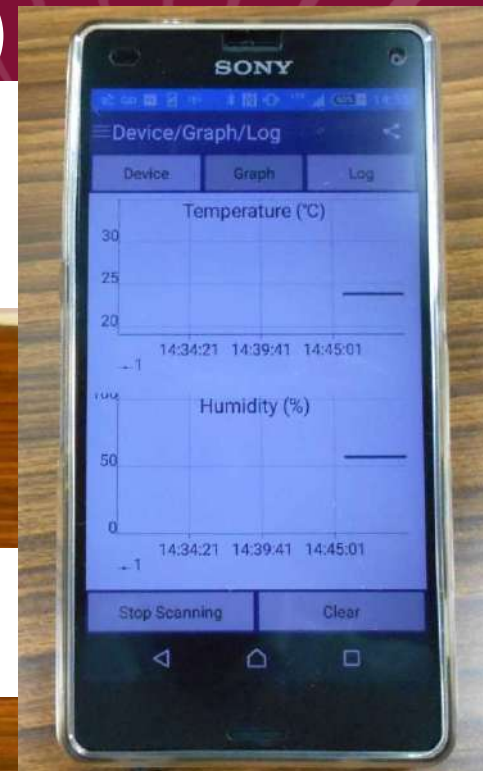

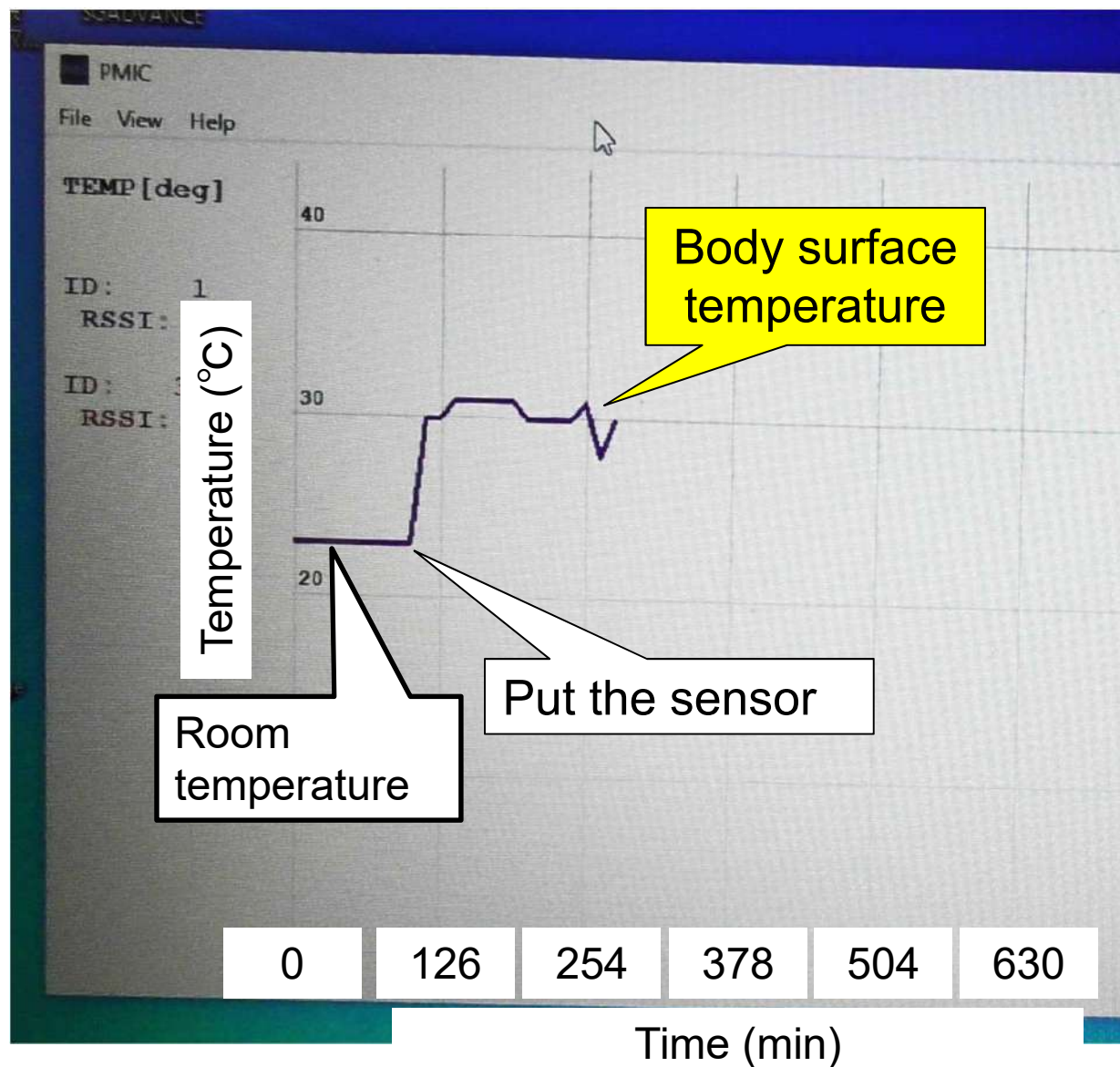



Fukuoka Tower

Fukuoka Tower is one of the TV transmission towers.
500MHz to 600MHz, radiating power of 6.0kW to 7.2kW



Fukuoka Tower, 234m High.

⇒ **Multi band transmitter**

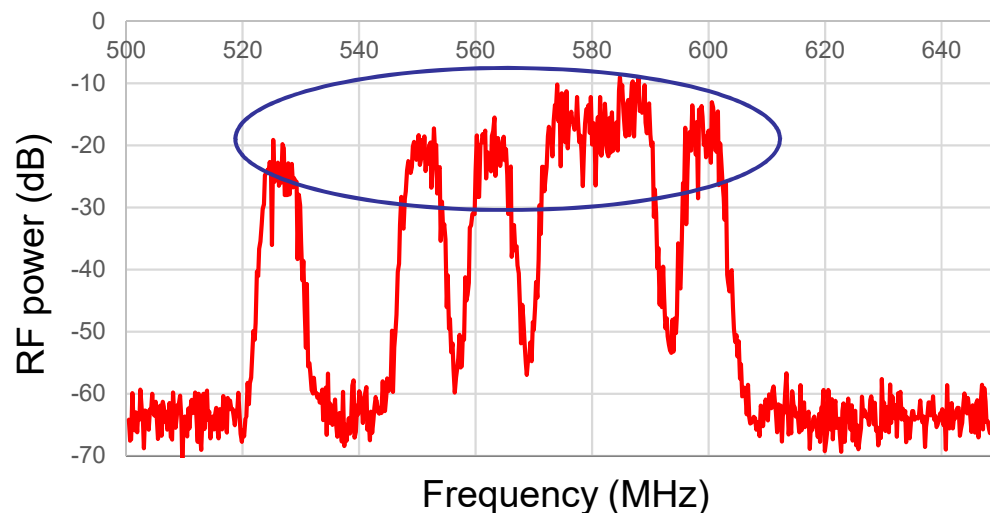

Measurement powers around
400m from Fukuoka Tower

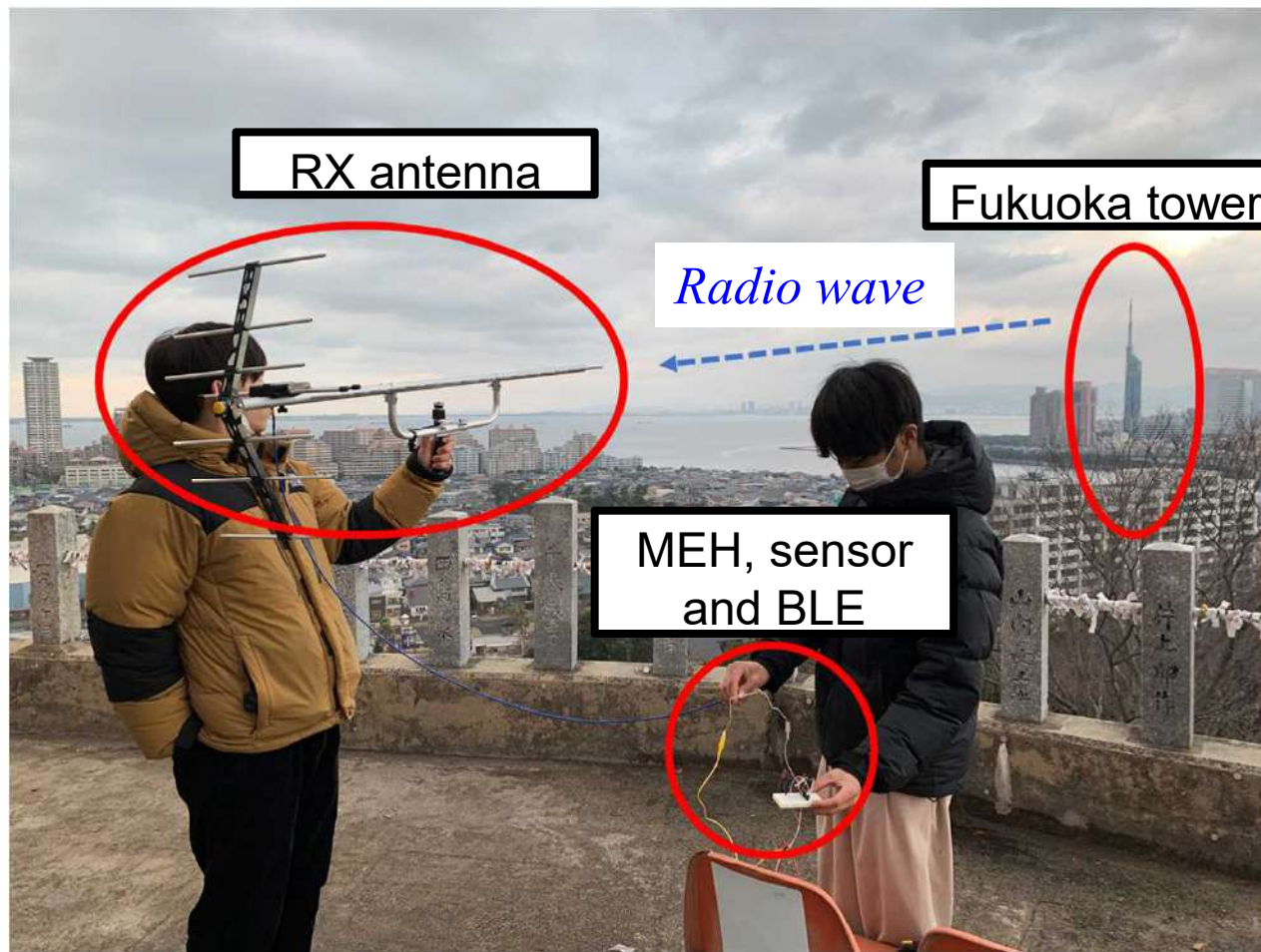

Experiment at Atago Shrine (1.8km point)



Distance from Fukuoka tower	Output open circuit DC voltage	Time taken for first communication
1.0km (with obstacles)	5.1V	220 s
1.8km	10V	50 s
3.4km	9.6V	82 s
7.5km	6.0V	192 s

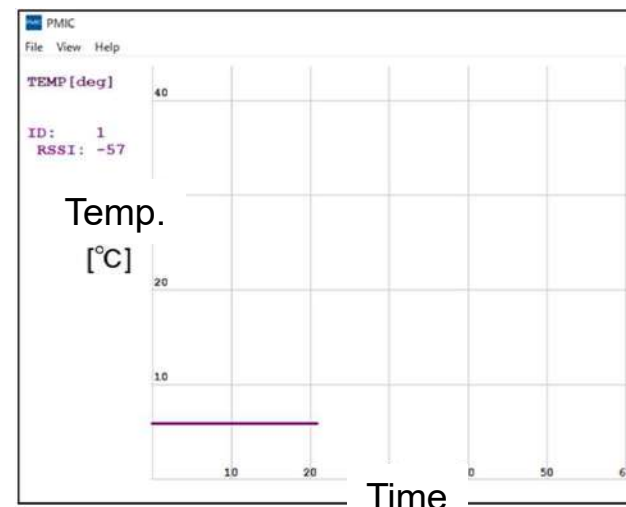

Temperature receiving data

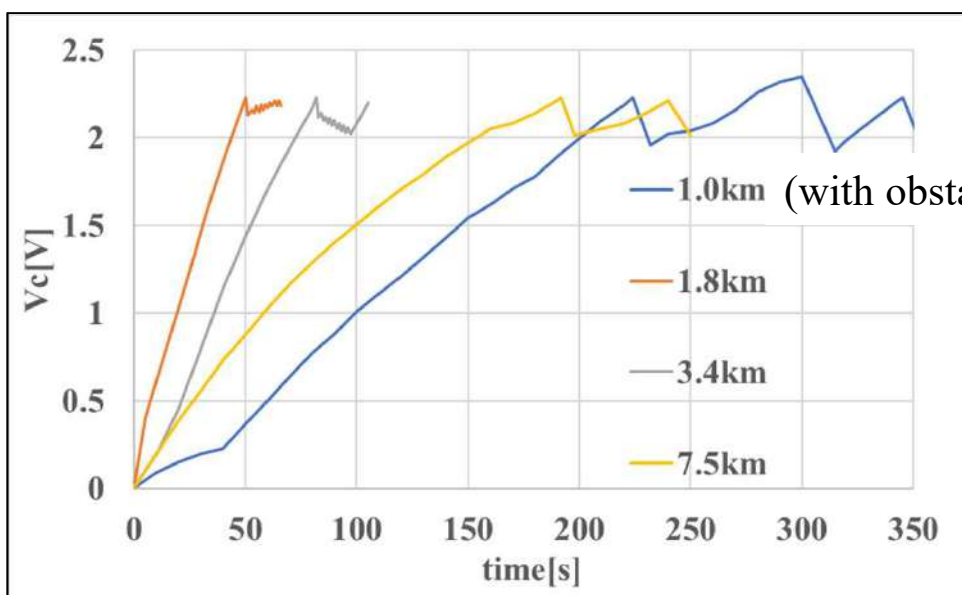

Capacitor voltage

Successful continuous communication using radio waves emitted from Fukuoka Tower.

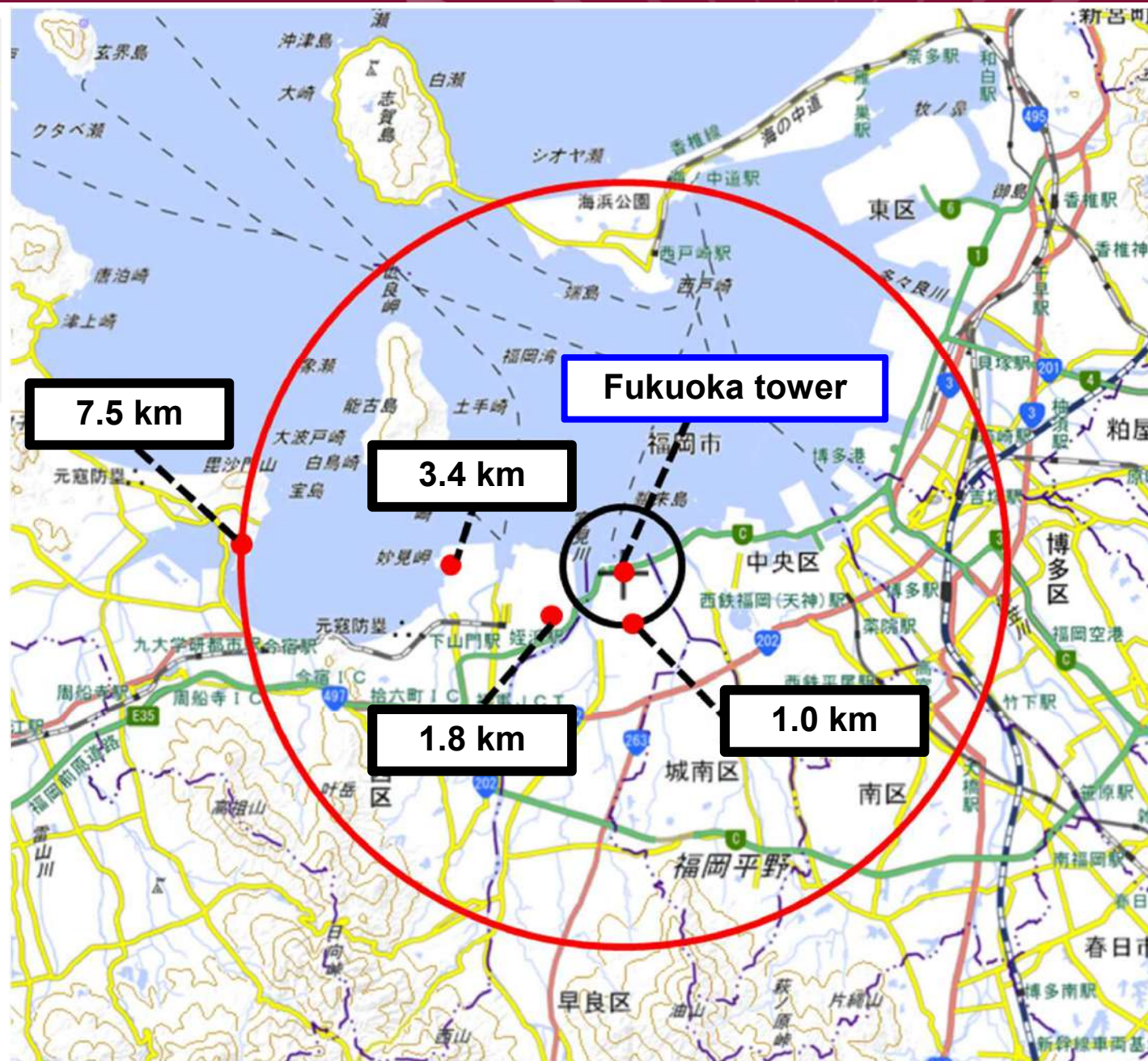
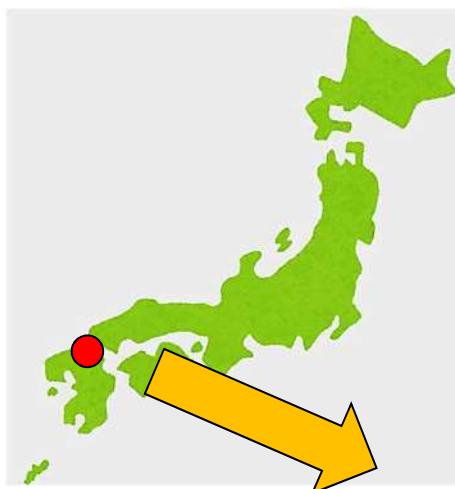

COLLABORATORS

Vital sensing project:

- ALSENS Inc.
- University Farm, Kyushu University
- Livestock Research Division, Oita Prefectural Agriculture, Forestry and Fisheries Research Center
- Oita Prefectural Agriculture, Forestry and Fisheries Research Center
- Kamiens Technology, Inc.



Implant sensing project:

- Fukuoka Dental College Medical & Dental Hospital
- Kyushu University Hospital
- Section of Oral Rehabilitation, Kyushu University
- LOGICAL PRODUCT Co.



Kyushu University
Faculty of Dental Science



LOGICAL PRODUCT



Infrastructure sensing project:

- Geodisaster Prevention Engineering Laboratory, Kyushu University
- Universiti Teknologi Malaysia, Malaysia
- Nahda University, Egypt
- NRIAG, , Egypt



COLLABORATORS Cont.

Wireless communication project:

- KYUSHU TEN LIMITED
- SEIKO ELECTRIC CO. LTD.
- Braveridge Co. Ltd.
- Logic Research Co. Ltd.
- Ericsson, France
- Pohang University of Science and Technology, Korea
- Sony
- Hinode, Ltd
- Tanaka Kikinzoku Kogyo
- Nagasaki University
- Research Institute of Electrical Communication, Tohoku University

